



GATE XL Previous Year Solved Question Papers

**G.A.T.E. (XL) 2016**

**Life Sciences**

**Examination**

*(Original Question Paper with Answer Key)*

GRADUATE APTITUDE TEST IN ENGINEERING



*For more question papers, please visit: [www.easybiologyclass.com](http://www.easybiologyclass.com)*

**Q. 1 – Q. 5 carry one mark each.**

- Q.1 The chairman requested the aggrieved shareholders to \_\_\_\_\_ him.
- (A) bare with            (B) bore with            (C) bear with            (D) bare
- Q.2 Identify the correct spelling out of the given options:
- (A) Managable            (B) Manageable            (C) Mangaable            (D) Managible
- Q.3 Pick the odd one out in the following:
- 13, 23, 33, 43, 53
- (A) 23                      (B) 33                      (C) 43                      (D) 53
- Q.4 R2D2 is a robot. R2D2 can repair aeroplanes. No other robot can repair aeroplanes.
- Which of the following can be logically inferred from the above statements?
- (A) R2D2 is a robot which can only repair aeroplanes.
- (B) R2D2 is the only robot which can repair aeroplanes.
- (C) R2D2 is a robot which can repair only aeroplanes.
- (D) Only R2D2 is a robot.
- Q.5 If  $|9y-6|=3$ , then  $y^2 - 4y/3$  is \_\_\_\_\_.
- (A) 0                      (B)  $+1/3$                       (C)  $-1/3$                       (D) undefined

**Q. 6 – Q. 10 carry two marks each.**

- Q.6 The following graph represents the installed capacity for cement production (in tonnes) and the actual production (in tonnes) of nine cement plants of a cement company. Capacity utilization of a plant is defined as ratio of actual production of cement to installed capacity. A plant with installed capacity of at least 200 tonnes is called a large plant and a plant with lesser capacity is called a small plant. The difference between total production of large plants and small plants, in tonnes is \_\_\_\_\_.

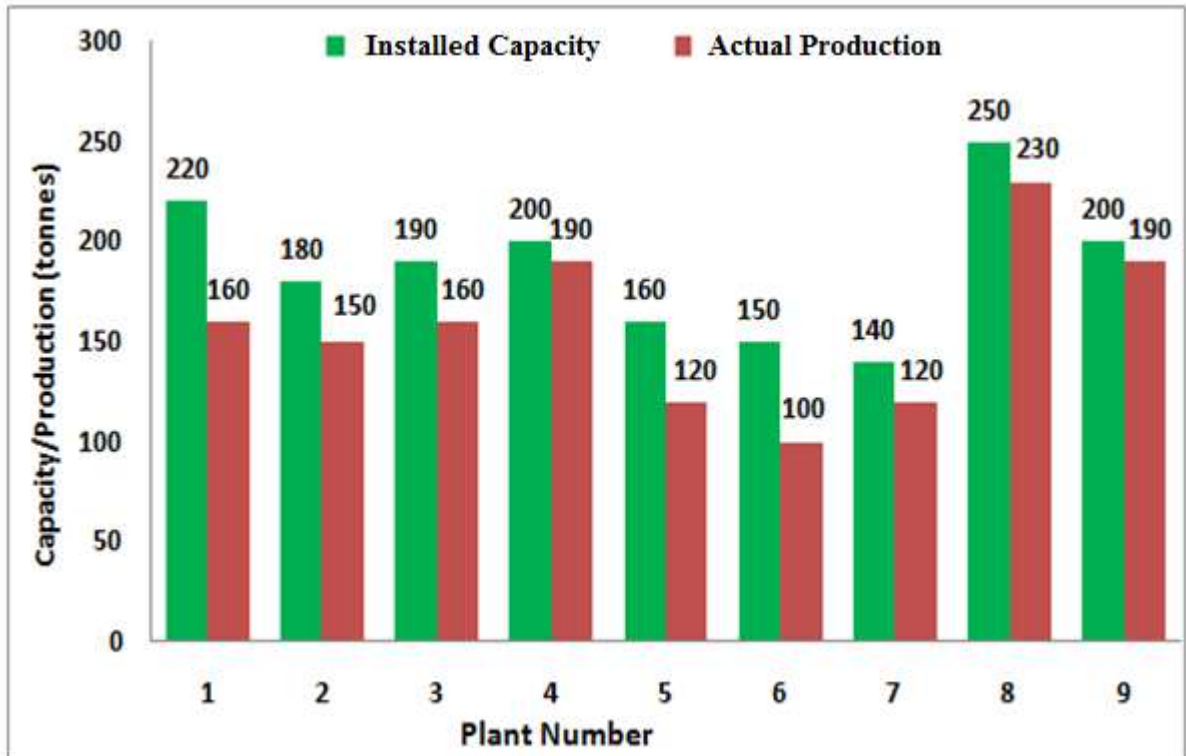

- Q.7 A poll of students appearing for masters in engineering indicated that 60 % of the students believed that mechanical engineering is a profession unsuitable for women. A research study on women with masters or higher degrees in mechanical engineering found that 99 % of such women were successful in their professions.

Which of the following can be logically inferred from the above paragraph?

- (A) Many students have misconceptions regarding various engineering disciplines.
- (B) Men with advanced degrees in mechanical engineering believe women are well suited to be mechanical engineers.
- (C) Mechanical engineering is a profession well suited for women with masters or higher degrees in mechanical engineering.
- (D) The number of women pursuing higher degrees in mechanical engineering is small.

Q.8 Sourya committee had proposed the establishment of Sourya Institutes of Technology (SITs) in line with Indian Institutes of Technology (IITs) to cater to the technological and industrial needs of a developing country.

Which of the following can be logically inferred from the above sentence?

Based on the proposal,

- (i) In the initial years, SIT students will get degrees from IIT.
- (ii) SITs will have a distinct national objective.
- (iii) SIT like institutions can only be established in consultation with IIT.
- (iv) SITs will serve technological needs of a developing country.

(A) (iii) and (iv) only.

(B) (i) and (iv) only.

(C) (ii) and (iv) only.

(D) (ii) and (iii) only.

Q.9 Shaquille O' Neal is a 60% career free throw shooter, meaning that he successfully makes 60 free throws out of 100 attempts on average. What is the probability that he will successfully make exactly 6 free throws in 10 attempts?

(A) 0.2508

(B) 0.2816

(C) 0.2934

(D) 0.6000

Q.10 The numeral in the units position of  $211^{870} + 146^{127} \times 3^{424}$  is \_\_\_\_\_.

**END OF THE QUESTION PAPER**

Please visit: [www.easybiologyclass.com](http://www.easybiologyclass.com) for:

- **Lecture Notes**
- **Biology PPTs**
- **Biology MCQs**
- **Online Mock Tests (MCQ)**
- **Practical Aids**
- **Model Question Papers of NET, GATE, DBT, ICMR Exams**
- **CSIR NET Life Sciences Previous Year Question Papers**
- **GATE Previous Year Question Papers**
- **DBT BET JRF Previous Year Question Papers**
- **ICMR JRF Entrance Exam Resources**
- **Higher Scondary Biology Resources**
- **Jobs Notifications**
- **Higher Studies in Biology / Life Sciences**
- **Seminar / Workshop/ Conference Notifications**
- *And many more....*



**EASY BI●OLOGY CLASS**

● Biology Made Easy ●

**H : CHEMISTRY ( COMPULSORY)****Q. 1 – Q. 5 carry one mark each.**

Q.1 The species having shortest B–F bond distance is

- (A)
- $\text{BF}_3$
- (B)
- $[\text{BF}_4]^-$
- (C)
- $\text{H}_3\text{N}\cdot\text{BF}_3$
- (D)
- $(\text{CH}_3)_2\text{O}\cdot\text{BF}_3$

Q.2 The total number of chair conformations possible for 1,2-dimethylcyclohexane is \_\_\_\_\_.

Q.3 'A harmful substance persists in the environment for a very long period of time'. The UNACCEPTABLE statement for this fact is

- (A) the substance degrades by second-order kinetics
- 
- (B) the substance degrades by first-order kinetics
- 
- (C) the substance is not biodegradable
- 
- (D) the substance has long half-life

Q.4 For an enzyme catalyzed reaction, the plot that correctly represents the relationship between the rate and temperature is

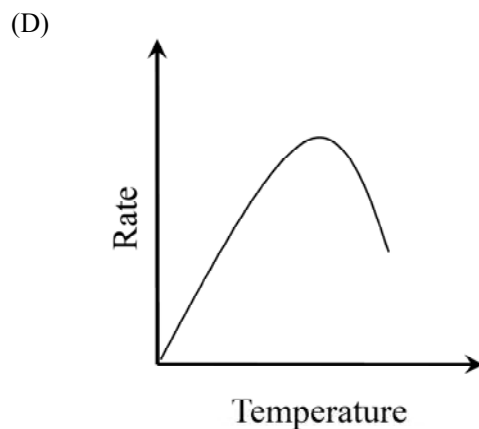
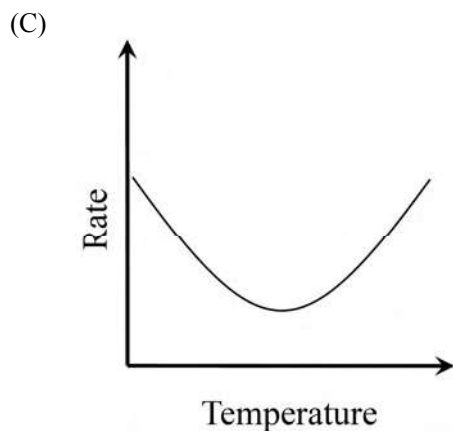
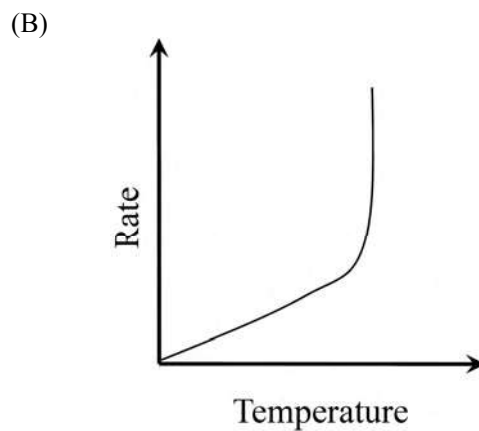
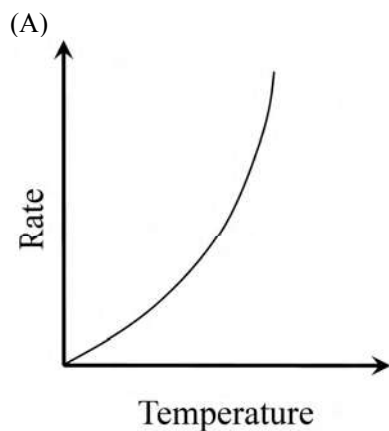

Q.5 Combinations of a process and equation are given below. The INCORRECT combination is

- (A) Constant pressure heating with no phase change;  $w = -\int_1^2 P dV$   
(B) Reversible adiabatic process in a perfect gas;  $\Delta U = \int_1^2 C_p(T) dT$   
(C) Reversible isothermal process in a perfect gas;  $w_{rev} = -\int_1^2 P dV$   
(D) Constant volume heating with no phase change;  $\Delta U = \int_1^2 C_v dT$

**Q. 6 – Q. 15 carry two marks each.**

Q.6 The correct comparison of  $pK_a$ 's of  $[\text{Fe}(\text{H}_2\text{O})_6]^{2+}$ ,  $[\text{Fe}(\text{H}_2\text{O})_6]^{3+}$ ,  $\text{V}_2\text{O}_5$  and  $\text{N}_2\text{O}_5$  is

- (A)  $[\text{Fe}(\text{H}_2\text{O})_6]^{3+} < [\text{Fe}(\text{H}_2\text{O})_6]^{2+}$  and  $\text{V}_2\text{O}_5 < \text{N}_2\text{O}_5$   
(B)  $[\text{Fe}(\text{H}_2\text{O})_6]^{3+} < [\text{Fe}(\text{H}_2\text{O})_6]^{2+}$  and  $\text{V}_2\text{O}_5 = \text{N}_2\text{O}_5$   
(C)  $[\text{Fe}(\text{H}_2\text{O})_6]^{2+} = [\text{Fe}(\text{H}_2\text{O})_6]^{3+}$  and  $\text{N}_2\text{O}_5 < \text{V}_2\text{O}_5$   
(D)  $[\text{Fe}(\text{H}_2\text{O})_6]^{3+} < [\text{Fe}(\text{H}_2\text{O})_6]^{2+}$  and  $\text{N}_2\text{O}_5 < \text{V}_2\text{O}_5$

Q.7 **Given:** The potential energy of two electrons separated by Bohr radius is 27.211 eV. The first Bohr radius of hydrogen is 0.5292 Å. The electron makes an orbit of radius 0.5295 Å around the nucleus in hydrogen.

The calculated ionization energy (eV) of hydrogen atom is \_\_\_\_\_.

Q.8 The crystal field stabilization energy (excluding pairing energy, if any) of  $[\text{CoCl}_4]^{2-}$  in  $\Delta_o$  units is \_\_\_\_\_.

Q.9 The correct statement is

- (A)  $\text{TlBr}_3$  is less soluble in water than  $\text{TlBr}$   
(B)  $\text{Ag}_2\text{S}$  is more soluble in water than  $\text{Ag}_2\text{O}$   
(C)  $\text{LiF}$  is less stable than  $\text{CsF}$   
(D)  $[\text{Co}(\text{NH}_3)_5\text{I}]^{2+}$  is less stable than  $[\text{Co}(\text{NH}_3)_5\text{F}]^{2+}$

Q.10 Ferrous sulfate on reaction with potassium hexacyanochromate(III) produces a brick red complex. The number of unpaired electrons on Fe in the red complex is \_\_\_\_\_.

Q.11 The major product formed in the following reaction is (ignore product stereochemistry)

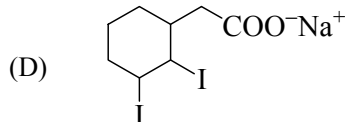
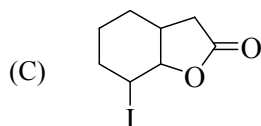
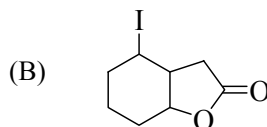
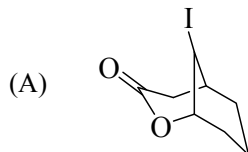

Q.12 When 1.0 g of urea (Molecular Weight = 60) is dissolved in 200 g of solvent **S**, the freezing point of **S** is lowered by 0.25 °C. When 1.5 g of a non-electrolyte **Y** is dissolved in 125 g of **S**, the freezing point of **S** is lowered by 0.20 °C. The molecular weight of **Y** is \_\_\_\_\_.

Q.13 The major product formed in the following reaction is

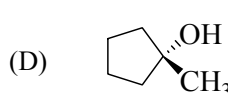
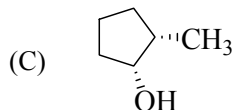
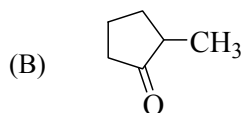
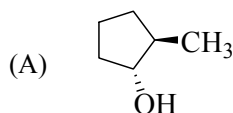
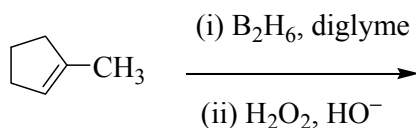

Q.14 For a weak acid at 298 K the molar conductivities (in  $ohm^{-1} m^2 mol^{-1}$ ), at infinite dilution and  $0.04 mol dm^{-3}$  are  $4.3 \times 10^{-3}$  and  $1.0 \times 10^{-3}$ , respectively. The degree of dissociation of the acid ( $0.04 mol dm^{-3}$ ) at 298 K is \_\_\_\_\_.

Q.15 For propene at 298 K, the molar enthalpy of hydrogenation is  $-124.27 kJ mol^{-1}$  and the standard enthalpy of formation is  $20.42 kJ mol^{-1}$ . For propane at 298 K, the standard enthalpy of formation in  $kJ mol^{-1}$  is \_\_\_\_\_.

**END OF THE QUESTION PAPER**



## XL-I : BIOCHEMISTRY

### Q. 1 – Q. 10 carry one mark each.

- Q.1 Heterologous expression of green fluorescent protein is possible because the genetic code is  
 (A) universal (B) triplet (C) degenerate (D) non-overlapping
- Q.2 Phosphoglucose isomerase was incubated with 0.2 M of glucose 6-phosphate. On reaching equilibrium, 55% of glucose 6-phosphate was converted to fructose 6-phosphate. The equilibrium constant for this reaction is \_\_\_\_\_.
- Q.3 Hydrolysis of a peptide involves cleavage of the bond between the atoms  
 (A) N and C<sub>α</sub> (B) C and O (C) C<sub>α</sub> and C (D) N and C
- Q.4 Inter-conversion of UDP-glucose and UDP-galactose is catalyzed by  
 (A) an oxidase (B) a kinase (C) an epimerase (D) a mutase
- Q.5 Gel filtration profile and corresponding activity data for a pure enzyme are shown in the figure below. The same enzyme sample on SDS-PAGE runs as a 30 kDa polypeptide.

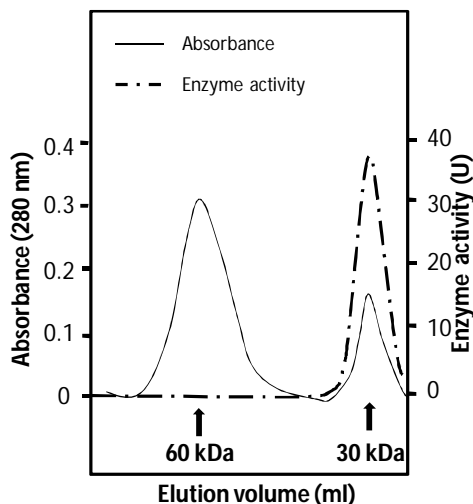

Which one of the following is the correct interpretation of the data?

- (A) Both monomer and dimer are active (B) Enzyme is active only as a monomer  
 (C) Protein does not form dimers (D) Enzyme is active only as a dimer
- Q.6 Amino acid residues predominantly involved in protein-DNA interactions are  
 (A) alanines (B) negatively charged  
 (C) prolines (D) positively charged
- Q.7 Cellulose serves as a structural polymer whereas starch does not. This is because cellulose contains  
 (A)  $\beta$ 1 $\rightarrow$ 4 linked glucose monomers and inter-chain hydrogen bonds  
 (B)  $\beta$ 1 $\rightarrow$ 4 linked glucose monomers and intra-chain hydrogen bonds  
 (C)  $\alpha$ 1 $\rightarrow$ 4 linked glucose monomers and inter-chain hydrogen bonds  
 (D)  $\alpha$ 1 $\rightarrow$ 4 linked glucose monomers and intra-chain hydrogen bonds

Q.8 Molar absorption spectra labeled (i), (ii) and (iii) for three different amino acids are shown below.

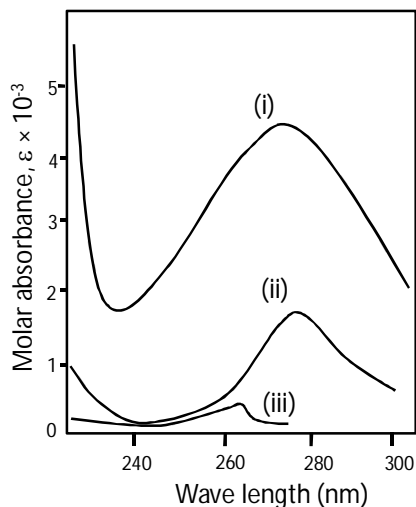

Which one of the following is the correct combination of spectral assignments?

- (A) (i) - tryptophan, (ii) - tyrosine, (iii) - phenylalanine
- (B) (i) - phenylalanine, (ii) - tryptophan, (iii) - tyrosine
- (C) (i) - proline, (ii) - tyrosine, (iii) - tryptophan
- (D) (i) - tryptophan, (ii) - proline, (iii) - phenylalanine

Q.9 The fluidity of a phospholipid membrane increases when the fatty acid

- (A) chain length increases and degree of unsaturation decreases
- (B) chain length decreases and degree of unsaturation increases
- (C) chain length decreases and degree of unsaturation decreases
- (D) chain length increases and degree of unsaturation increases

Q.10 Polypeptides are biosynthesized on the ribosomes inside the cell. Chemical synthesis of polypeptides is also possible through Merrifield's solid-phase peptide synthesis. In both the cases the polypeptide chain is extended one amino acid at a time. The direction of polypeptide synthesis is from

- (A) C-terminus to N-terminus in both the cases
- (B) N-terminus to C-terminus in both the cases
- (C) C-terminus to N-terminus on the ribosomes and N-terminus to C-terminus in solid-phase synthesis
- (D) N-terminus to C-terminus on the ribosomes and C-terminus to N-terminus in solid-phase synthesis

**Q. 11 – Q. 20 carry two marks each.**

Q.11 Four groups of metabolites are given below. Choose the group in which all the compounds contain at least one bond whose  $\Delta G'^{\circ}$  of hydrolysis is  $\leq -7.0$  kcal/mole.

- (A) Glucose 1-phosphate, Adenosine triphosphate, Fructose 1,6-bisphosphate
- (B) Creatine phosphate, Acetyl phosphate, Succinyl CoA
- (C) Glycerol 3-phosphate, Acetyl CoA, 1,3-Bisphosphoglycerate
- (D) Glucose 6-phosphate, Phosphoenolpyruvate, Adenosine diphosphate

- Q.12 The  $\Delta G'^{\circ}$  for the malate dehydrogenase catalyzed step of Krebs cycle is +7.1 kcal/mole. Nevertheless, the conversion of malate to oxaloacetate *in vivo* proceeds spontaneously because the subsequent reaction that consumes oxaloacetate has a  $\Delta G'^{\circ}$  of
- (A) -3.0 kcal/mole  
 (B) +3.0 kcal/mole  
 (C) -7.7 kcal/mole  
 (D) +7.7 kcal/mole
- Q.13 When freshly isolated intact mitochondria were incubated with ADP and inorganic phosphate neither the oxygen consumption nor the ATP synthesis could be detected. Addition of succinate resulted in increased oxygen consumption as well as ATP synthesis with time. Subsequent addition of cyanide to this system will result in which one of the following?
- (A) Both oxygen consumption and ATP synthesis are inhibited  
 (B) Oxygen consumption continues but ATP synthesis is inhibited  
 (C) Oxygen consumption is inhibited but ATP synthesis continues  
 (D) Both oxygen consumption and ATP synthesis continue
- Q.14 Three micrograms of a circular plasmid of 4200 bp was digested with a restriction enzyme and subjected to agarose gel electrophoresis. Five DNA fragments of different sizes were observed and their sizes summed up to 4200 bp. The number of picomoles of DNA ends generated after complete digestion with the enzyme is \_\_\_\_\_.
- (Given: average molecular weight of each base pair is 660 Da)

- Q.15 An enzyme was purified using ion-exchange chromatography and the results are shown in the table below.

Step	Volume (ml)	Total protein (mg)	Total activity (U)
Cell extract	8000	400	800
DEAE Sephacel	10	2	200

Which one of the following is the correct interpretation of these data?

- (A) 50 fold purification was achieved with 25% yield of the enzyme  
 (B) 25 fold purification was achieved with 50% yield of the enzyme  
 (C) 50 fold purification was achieved with 4% yield of the enzyme  
 (D) 200 fold purification was achieved with 25% yield of the enzyme
- Q.16 Aspartate residues are found in the active sites of many enzymes. The  $pK_a$  for the  $\beta$ -carboxylate of aspartate is 3.86. At physiological pH this group can function as
- (A) a nucleophile and a conjugate acid                      (B) an electrophile and a conjugate acid  
 (C) a nucleophile and a conjugate base                      (D) an electrophile and a conjugate base
- Q.17 Kinetic parameters for the enzyme fumarase with three different substrates are given below.

Substrate	$K_M$ ( $\mu M$ )	$k_{cat}$ ( $sec^{-1}$ )
Fluorofumarate	27	2700
Fumarate	5	800
Chlorofumarate	111	20

The specificity of fumarase for the substrates decreases in the order

- (A) Fluorofumarate > Fumarate > Chlorofumarate  
 (B) Chlorofumarate > Fluorofumarate > Fumarate  
 (C) Fumarate > Fluorofumarate > Chlorofumarate  
 (D) Fumarate > Chlorofumarate > Fluorofumarate

- Q.18 A polypeptide with the amino acid sequence 'AGKPDHEKAHL' was dissolved in a buffer of pH 1.8. The predominant form of the polypeptide will have a net charge of  
 (A) +4 (B) +5 (C) +7 (D) +11
- Q.19 An N-terminal His-tagged protein of molecular weight 40 kDa was purified using Ni-NTA column. This protein sample was subjected to SDS-PAGE. A western blot of the same using anti-His antibodies is shown below.

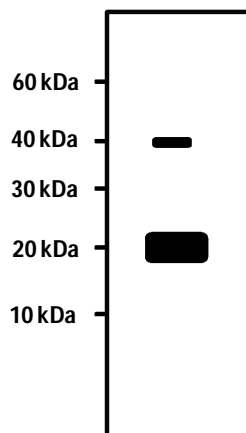

- Which one of the following interpretations is correct?  
 (A) Only the His-tag of the protein got removed  
 (B) The protein forms oligomers  
 (C) The purified protein sample is homogeneous  
 (D) The protein has a stable N-terminal 20 kDa domain
- Q.20 The sequence of a polypeptide that forms a transmembrane helix is shown below.
- |            |            |            |            |        |
|------------|------------|------------|------------|--------|
| 1          | 11         | 21         | 31         | 41     |
|            |            |            |            |        |
| TGERVQLAHH | FSEPEITLII | FGVMAGVIGT | ILLASYGIRR | LIKKSP |
- Which one of the following segments of the peptide is most likely to span the membrane?  
 (A) E3-G22 (B) V5-A25 (C) E15-A34 (D) F21-R40

**END OF THE QUESTION PAPER**

## J : BOTANY

### Q. 1 – Q. 10 carry one mark each.

- Q.1 Which of the following is most abundant in the aleurone layer of wheat seeds?  
(A) Tannin (B) Starch (C) Protein (D) Lipid
- Q.2 Which of the following does NOT use xylem to transport water?  
(A) *Miscanthus* (B) *Marchantia* (C) *Selaginella* (D) *Magnolia*
- Q.3 Which of the following is the closest ancestor of all land plants?  
(A) Blue green algae (B) Red algae  
(C) *Chara* (D) *Coleochaeteae*
- Q.4 4',6 diamidino 2-phenylindole (DAPI) is a fluorescent dye used to stain the nucleus. Which of the following plant cells, when mature, cannot be stained by DAPI?  
(A) Trichomes (B) Tracheids (C) Collenchyma (D) Mesophyll
- Q.5 The uptake of nitrogen (N) and phosphorus (P) by plant roots often involves interaction between root and some symbiotic organisms. Which of the following associations is most commonly found for the uptake of these two nutrients?  
(A) Bacteria for N, algae for P  
(B) Bacteria for N, nematodes for P  
(C) Nematodes for N, fungi for P  
(D) Bacteria for N, mycorrhizae for P

Q.6 Which of the following summarizes the role of Casparian strip in transport of water in the root?

(A) Symplast to Apoplast

(B) Apoplast to Symplast

(C) Phloem to Xylem

(D) Xylem to Phloem

Q.7 Atropine is a drug used in the management of pesticide poisoning. Which of the following plants can serve as a commercial source of this anticholinergic drug?

(A) *Datura metel*

(B) *Medicago truncatula*

(C) *Mangifera indica*

(D) *Arachis hypogaea*

Q.8 Which of the following is **NOT** involved in plant immune response?

(A) Antimicrobial proteins

(B) Hypersensitive response

(C) Pattern recognition receptors

(D) Interleukins

Q.9 Which of the following is a neutral phenomenon?

(A) Natural selection

(B) Sexual selection

(C) Genetic drift

(D) Population bottleneck

Q.10 When a plant is infected by a pathogen at one site, the distal parts of the plant and neighboring plants develop increased resistance to subsequent pathogen attack. Which of the following molecules mediates this long-distance signal?

(A) Nitric oxide

(B) Ethylene

(C) Jasmonic acid and its derivatives

(D) Salicylic acid and its derivatives

**Q. 11 – Q. 20 carry two marks each.**

Please visit: [www.easybiologyclass.com](http://www.easybiologyclass.com) for:

- **Lecture Notes**
- **Biology PPTs**
- **Biology MCQs**
- **Online Mock Tests (MCQ)**
- **Practical Aids**
- **Model Question Papers of NET, GATE, DBT, ICMR Exams**
- **CSIR NET Life Sciences Previous Year Question Papers**
- **GATE Previous Year Question Papers**
- **DBT BET JRF Previous Year Question Papers**
- **ICMR JRF Entrance Exam Resources**
- **Higher Scondary Biology Resources**
- **Jobs Notifications**
- **Higher Studies in Biology / Life Sciences**
- **Seminar / Workshop/ Conference Notifications**
- *And many more....*



**EASY BI●OLOGY CLASS**

● Biology Made Easy ●

- Q.11 An inbred line of a plant with red flower and tall stem was crossed to another inbred line with white flower and short stem. The  $F_1$  plants, which all had red flower and tall stem, were backcrossed to the line with white flower and short stem, and the following  $F_2$  individuals were obtained: 103 red, tall; 89 white, short; 26 red, short; and 23 white, tall. What is the recombination percentage between the flower color locus and the stem height locus.
- (A) 19-21%                      (B) 49-51%                      (C) 79-81%                      (D) 0-2%

- Q.12 Consider the following pathway controlling time to flowering in wheat:

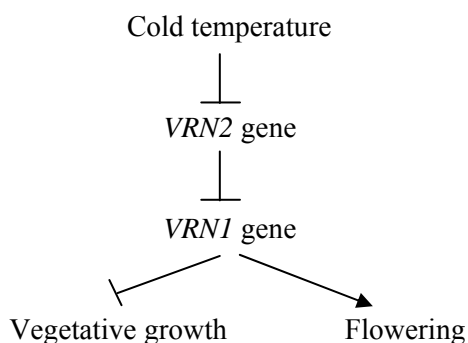

If batch  $P$  of wheat seed is vernalized before sowing and batch  $Q$  is not vernalized, then which of the following statements is most likely to be correct?

- (A)  $P$  will have lower  $VRN2$  transcript and will flower later than  $Q$   
 (B)  $P$  will have lower  $VRN2$  transcript and will flower earlier than  $Q$   
 (C)  $P$  will have higher  $VRN2$  transcript and will flower later than  $Q$   
 (D)  $P$  and  $Q$  will have equal  $VRN2$  transcript and will flower at the same time
- Q.13 The three plots P, Q and R (in different units) in the graph below represent the dependence of photosynthesis rate (PR), leaf expansion rate (LER) and translocation rate of assimilates (TR) in a plant on leaf water potential. Which of the following statements is correct in this regard?

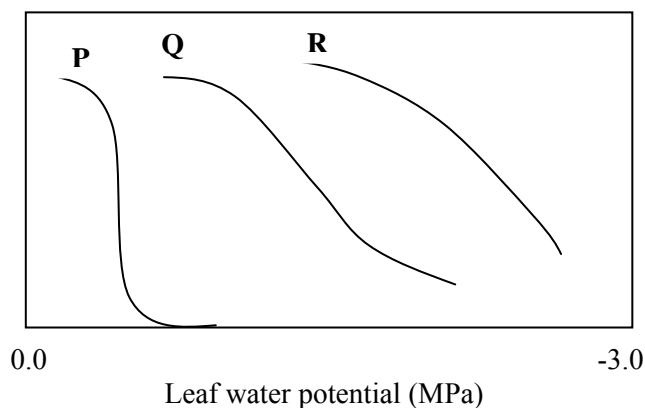



- (A) P represents LER; Q represents TR; R represents PR
- (B) P represents TR; Q represents PR; R represents LER
- (C) P represents PR; Q represents LER; R represents TR
- (D) P represents LER; Q represents PR; R represents TR

Q.14 PIN proteins are plasma membrane-localized carrier proteins required for polar auxin transport in plants. Four different carrier proteins are shown in the diagram below labeled P1-P4. Arrow indicates the direction of auxin flow. Which among these is most likely to be a PIN protein?

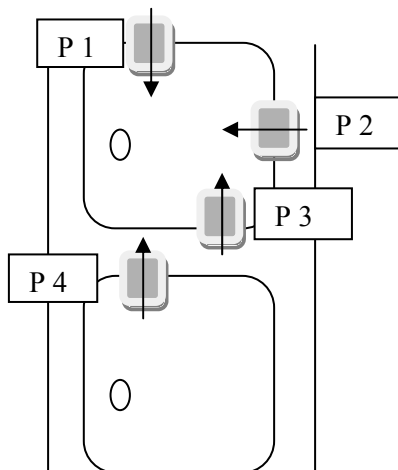

- (A) P 1
- (B) P 2
- (C) P 3
- (D) P 4

Q.15 An RFLP marker shows sequence polymorphism in two ecotypes (X and Y) of a plant. In ecotype X, the marker contains one GAATTC site in its sequence, whereas in Y it has the sequence GAAATC at the same site. The rest of the sequence is identical in both ecotypes. In a genotyping experiment, the marker was PCR amplified from four different seedlings (P, Q, R, S), completely digested with *EcoRI* and the products were analyzed by electrophoresis. The diagram below shows the band patterns obtained. Based on the information provided, which of the following statements is correct?

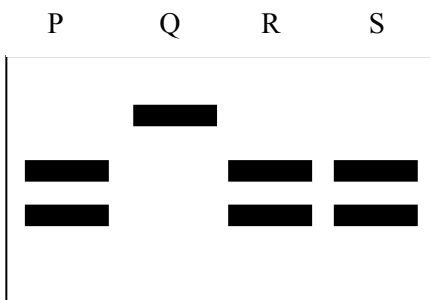

- (A) Seedling Q belongs to ecotype Y
- (B) Seedling Q belongs to ecotype X
- (C) Seedling P belongs to ecotype Y
- (D) Seedling R belongs to ecotype Y

Q.16 The cell surface expands differently in different plant cells. Two common modes of expansion are shown below (X and Y). Each rectangular box represents a cell marked with dots on its surface. The spacing between the dots changes after the cell has undergone expansion as indicated by the arrow. Which of the following statements is correct with respect to the growth of root hair and pollen tube?

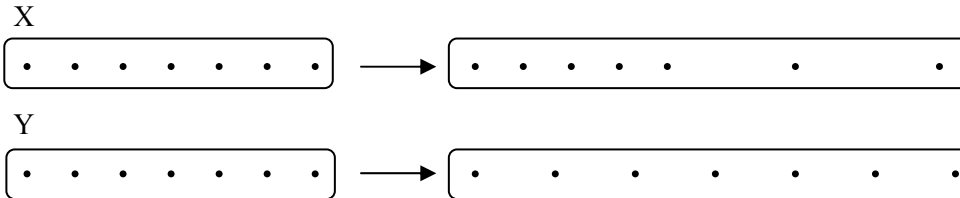

- (A) Both grow as shown in X
- (B) Both grow as shown in Y
- (C) Pollen tube grows as shown in X, root hair grows as shown in Y
- (D) Root hair grows as shown in X, pollen tube grows as shown in Y

Q.17 Hardy Weinberg's equilibrium for a locus with two alleles  $p$  and  $q$  is mathematically defined as  $P^2 + Q^2 + 2PQ = 1$ . Which of the following equations represents the corresponding equilibrium for a locus with three alleles  $p, q$  and  $r$ ? ( $P, Q$  and  $R$  represent the frequencies of  $p, q$  and  $r$ , respectively)

- (A)  $P^3 + Q^3 + R^3 + 3PQR = 1$
- (B)  $P^2 + Q^2 + R^2 + 2PQ + 2QR + 2PR = 1$
- (C)  $P^2Q + Q^2R + R^2P + 2PQ + 2QR + 2PR = 1$
- (D)  $P^2 + Q^2 + R^2 + 2P^2Q + 2Q^2R + 2P^2R = 1$

Q.18 The continuous and dashed lines in the following graph represent the velocity of sap flow in two different parts of a plant at different times of a day. Which of the following statements is most appropriate based on this graph?

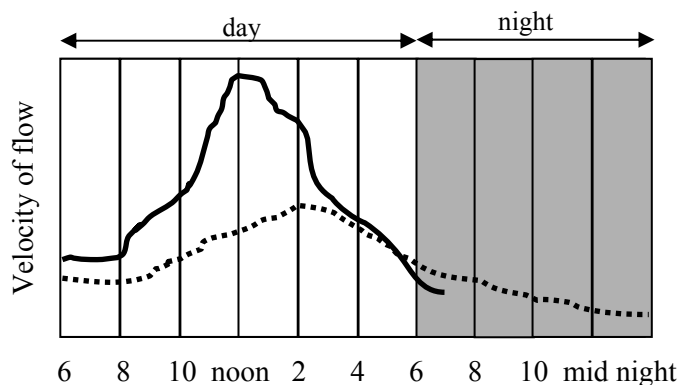

- (A) The continuous line represents the trunk, and the dotted line a twig
- (B) The continuous line represents a twig, and the dotted line the trunk
- (C) The continuous line represents a root, and the dotted line a twig
- (D) The continuous line represents a root, and the dotted line the trunk

Q.19 Given below are the names of some genes/enzymes and their use in genetically modified crops. Match the two columns.

Gene/enzyme -----	Commercial use -----
P. Bt gene	i. Golden rice
Q. $\beta$ -carotene biosynthetic genes	ii. insect resistance
R. ACC deaminase	iii. herbicide resistance
S. EPSP synthase	iv. fruit ripening

- (A) P, i; Q, ii; R, iii; S, iv  
 (B) P, ii; Q, i; R, iv; S, iii  
 (C) P, iii; Q, i; R, ii; S, iv  
 (D) P, ii; Q, i; R, iii; S, iv

Q.20 The basic tenets of the ABC model of Arabidopsis flower development are shown below along with a diagram.

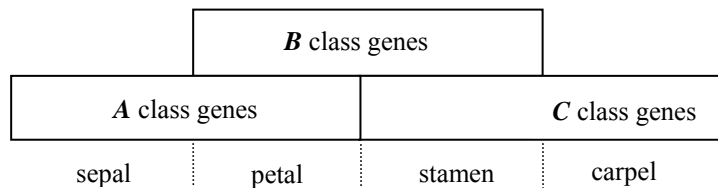

- i. **A** class genes acting alone determine sepal identity
- ii. **A** and **B** class genes acting together determine petal identity
- iii. **B** and **C** class genes acting together determine stamen identity
- iv. **C** class genes acting alone determine carpel identity
- v. **A** and **C** class genes mutually inhibit each other

Which of the following organ arrangements is found in an **A** class mutant?

- (A) sepal; petal; stamen; carpel  
 (B) carpel; stamen; stamen; carpel  
 (C) petal; petal; stamen; carpel  
 (D) stamen; stamen; stamen; carpel

**END OF THE QUESTION PAPER**

---

**XL-K: MICROBIOLOGY****Q. 1 – Q. 10 carry one mark each.**

- Q.1 Which one of the following is the most appropriate technique to determine the relatedness of two bacterial species?
- (A) DNA hybridization (B) Doubling time measurement  
(C) Biochemical characterization (D) Plasmid profiling
- Q.2 Which one of the following phages undergoes non-integrative lysogenic phase?
- (A)  $\lambda$  (B) P1 (C) T7 (D) M13
- Q.3 Which one of the following is **NOT** a part of human microbiome?
- (A) *Propionibacterium acnes* (B) *Lactobacillus casei*  
(C) *Streptococcus suis* (D) *Bacteroides fragilis*
- Q.4 Resident macrophages of \_\_\_\_\_ are called Kupffer cells.
- (A) brain (B) liver (C) lung (D) kidney
- Q.5 The enzyme responsible for generation of hypochlorous ions during phagocytosis is
- (A) NADPH oxidase (B) catalase  
(C) myeloperoxidase (D) superoxide dismutase
- Q.6 Teichoic acid is composed of repetitive units of
- (A) keto-deoxy octanoic acid (B) glucose  
(C) *N*-acetyl glucosamine (D) glycerol
- Q.7 Biofilm produced by bacteria is detected by
- (A) Saffranin (B) Malachite green (C) Basic fuchsin (D) Congo red

- Q.8 The precursor for the synthesis of aromatic amino acids is  
(A) phosphoenolpyruvate (B) pyruvate  
(C) oxaloacetate (D)  $\alpha$ -ketoglutarate
- Q.9 The net yield of NADH in the Embden-Meyerhof pathway in *E. coli* is\_\_\_\_\_.
- Q.10 *E. coli* ribonuclease contains 124 amino acids. The number of nucleotides present in the gene encoding the protein is \_\_\_\_\_.

**Q. 11 – Q. 20 carry two marks each.**

- Q.11 Which of the following infectious agents cross the blood-brain barrier?  
(P) *Streptococcus pneumoniae* (Q) Coxsackie virus  
(R) Rotavirus (S) *Streptococcus pyogenes*  
(A) P & S (B) R & S (C) P & Q (D) Q & R
- Q.12 At  $OD_{540nm} = 0.5$ , which one of the following bacterial mono-dispersed cell suspensions will have (i) maximum and (ii) minimum number of cells?  
(P) *Mycoplasma pneumoniae* (Q) *Micrococcus luteus*  
(R) *Bacillus subtilis* (S) *Escherichia coli*  
(A) P & Q (B) P & R (C) Q & R (D) R & S

Q.13 Which one of the following enzyme combinations allows some bacteria to utilize acetate through glyoxylate pathway?

- (P) Isocitrate lyase                      (Q) Isocitrate dehydrogenase  
(R) Succinyl CoA synthetase      (S) Malate synthase

- (A) P & S                      (B) P & R                      (C) Q & S                      (D) Q & R

Q.14 The decimal reduction time ( $D_{121}$ ) for *Clostridium botulinum* spores is 0.2 min. The time required to reduce the spore count from  $10^{12}$  to one spore at  $121^\circ\text{C}$  is \_\_\_\_\_ minutes.

Q.15 *E. coli* requires three genes, *galK* (kinase), *galT* (transacetylase) and *galE* (epimerase) to utilize galactose. If there is a mutation in any one of these genes, the mutant cannot utilize galactose. Which one of the following combinations of merodiploids will support the growth of mutants on galactose?

- (P)  $galK^+ galT^+ galE^- / galK^- galT^+ galE^-$   
(Q)  $galK^- galT^+ galE^- / galK^+ galT^- galE^+$   
(R)  $galK^+ galT^- galE^- / galK^- galT^- galE^+$   
(S)  $galK^+ galT^+ galE^- / galK^+ galT^- galE^+$

- (A) P & Q                      (B) P & R                      (C) R & S                      (D) Q & S

Q.16 Nitrogenase reduces  $\text{N}_2$  to  $\text{NH}_3$ . Metal co-factors required for this activity are \_\_\_\_\_.

- (A) Fe & Cu                                      (B) Mo & Fe  
(C) Mo & Mn                                      (D) Cu & Mn

Q.17 If a bacterial cell contains 5,000 genes and if the average mutation frequency per gene is  $2 \times 10^{-4}$  per generation, the average number of new mutations per generation is \_\_\_\_\_.

- Q.18 The growth profile of *E. coli* on glucose plus lactose is shown below. The specific growth rate of the second exponential phase is \_\_\_\_ h<sup>-1</sup>.

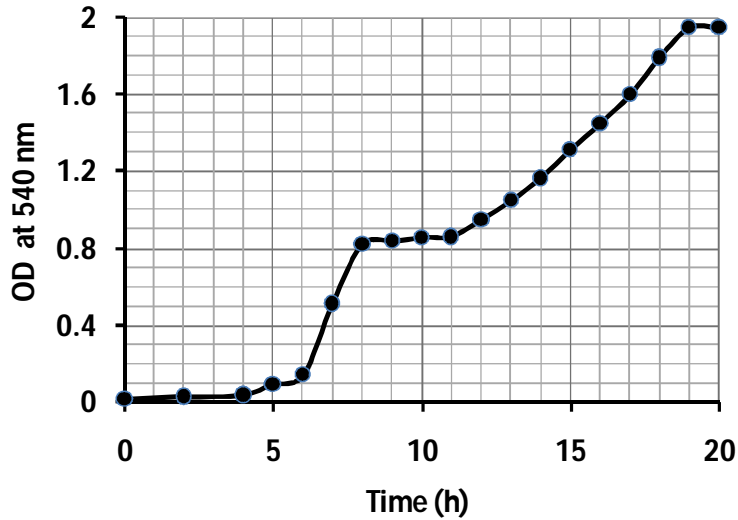

- Q.19 Match the cell structure components given in **Group I** with appropriate functions from **Group II**.

**Group I**

- (P) Cell membrane  
(Q) Purple membrane  
(R) Cisternae  
(S) Outer membrane

**Group II**

- (I) Nutrient transport  
(II) Photosynthesis  
(III) Active transport  
(IV) Protein glycosylation  
(V) Light-driven proton transport

- (A) P-I, Q-V, R-II, S-III  
(C) P-III, Q-II, R-V, S-I

- (B) P-I, Q-II, R-IV, S-III  
(D) P-III, Q-V, R-IV, S-I

- Q.20 Match the antibiotics given in **Group I** with appropriate targets from **Group II**.

**Group I**

- (P) Nalidixic acid  
(Q) Tetracycline  
(R) Erythromycin  
(S) Rifampin

**Group II**

- (I) RNA polymerase  
(II) DNA gyrase  
(III) DNA polymerase  
(IV) 50S ribosomal subunit  
(V) Aminoacyl tRNA

- (A) P-III, Q-IV, R-V, S-I  
(C) P-II, Q-V, R-IV, S-I

- (B) P-V, Q-I, R-IV, S-II  
(D) P-II, Q-V, R-I, S-IV

**END OF THE QUESTION PAPER**



**L: Zoology****Q. 1 – Q. 10 carry one mark each.**

- Q.1 Acorn worms (*Saccoglossus sp.*) belong to which ONE of the following Phyla?  
(A) Platyhelminthes (B) Achelminthes  
(C) Hemichordata (Chordata) (D) Annelida
- Q.2 A population of Bees develops resistance to pesticides and the trait gets fixed within a few generations. This is an example of  
(A) macroevolution. (B) disruptive selection.  
(C) stabilizing selection. (D) microevolution.
- Q.3 The nature of the polymorphic DNA fragment used for mapping is  
(A) dominant. (B) partial dominant.  
(C) co-dominant. (D) recessive.
- Q.4 The sex of a *Drosophila melanogaster*, which has 4 copies of X-chromosomes and 4 sets of autosomes will be  
(A) female. (B) male. (C) metafemal. (D) metamale.
- Q.5 Which of the following cations are found in higher concentration in extracellular fluid as compared to intracellular fluid in animals?  
(A)  $\text{Na}^+$  and  $\text{Ca}^{++}$  (B)  $\text{K}^+$  and  $\text{Ca}^{++}$  (C)  $\text{K}^+$  and  $\text{Mg}^{++}$  (D)  $\text{Na}^+$  and  $\text{Mg}^{++}$
- Q.6 Detoxification of alcohol occurs in liver cells where peroxisomal enzymes remove hydrogen from it, which is  
(A) combined with water molecules to generate hydrogen peroxide.  
(B) used to break down hydrogen peroxide.  
(C) transferred to the mitochondria.  
(D) transferred to oxygen molecules to generate hydrogen peroxide.
- Q.7 When cells are treated with cyanide, which ONE of the following organelles will have the highest level of cyanide inside?  
(A) Mitochondria (B) Peroxisomes (C) Lysosomes (D) Endoplasmic reticulum
- Q.8 Toxoplasmosis in humans is caused by *Toxoplasma gondii*, an obligate intracellular parasite with two different life cycles, sexual and asexual. The sexual cycle occurs in which ONE of the following definitive hosts?  
(A) Dog (B) Cat (C) Rat (D) Human
- Q.9 Which ONE of the following is often a life-threatening systemic inflammatory response?  
(A) Tuberculosis  
(B) Lupus erythematosus  
(C) Septic shock  
(D) Hypertension
- Q.10 During the gastrulation stage of amphibian development, ectoderm formation takes place by the expansion of epithelial cell sheet over mesodermal cells. This type of cell movement is termed as  
(A) ingression. (B) epiboly. (C) involution. (D) delamination.

**Q. 11 – Q. 20 carry two marks each.**

- Q.11 In a population, 600 individuals have MM blood group, 300 have MN blood group and 100 have NN blood group. What will be the frequencies of M and N alleles in this population?
- (A) M 0.75 and N 0.25 (B) M 0.65 and N 0.35  
(C) M 0.85 and N 0.15 (D) M 0.55 and N 0.45
- Q.12 The molecules, hexanoic acid, lysine, histidine and glucose, each contain 6 carbon atoms, but have completely different properties due to the presence of different functional groups. Which ONE of these molecules has a high calorific value?
- (A) Lysine (B) Hexanoic acid (C) Glucose (D) Histidine
- Q.13 The primary function of polysaccharides attached to glycoproteins in the animal cell membrane is to
- (A) facilitate diffusion of molecules down their concentration gradients.  
(B) maintain membrane fluidity at low temperatures.  
(C) maintain the integrity of a fluid mosaic membrane.  
(D) mediate cell-to-cell recognition.
- Q.14 Which ONE of the following mechanisms is used to coordinate the expression of multiple, related genes in eukaryotic cells?
- (A) Environmental signals enter the cell and bind directly to promoters.  
(B) Genes share a common intragenic sequence, and allow several activators to turn on their transcription, regardless of location.  
(C) Genes are organized into large operons, allowing them to be transcribed as a single unit.  
(D) Genes are organized into clusters, with local chromatin structures influencing the expression of all the clustered genes at once.
- Q.15 In an experiment involving development of 64-cell stage sea urchin, an isolated animal hemisphere was combined with isolated micromeres. Which ONE of the following will be the resulting structure?
- (A) A ball of ectomesodermal cells (B) A ciliated ball of ectodermal cells  
(C) A recognizable pluteus larva (D) A ball of endodermal cells
- Q.16 Glycoprotein hormones, hCG and eCG, are synthesized in women and mares respectively, during pregnancy. Both of these chorionic gonadotropin hormones
- (A) have only LH-like activity in their respective species.  
(B) have only FSH-like activity in other species.  
(C) are biologically inactive in other species.  
(D) are routinely employed to promote final stages of follicular maturation, ovulation and to treat infertility in women.
- Q.17 *Entamoeba histolytica* is an intestinal parasite that causes dysentery in humans. This parasite resides in the isotonic environment of intestine and other tissues in the human body and does not possess contractile vacuoles. If this parasite is placed in fresh water, it will
- (A) survive for long time, until they re-enter the host environment.  
(B) die due to hypoosmotic shock.  
(C) not survive in water as they require high salt content.  
(D) die due to hyperosmotic shock.
- Q.18 In an experiment involving *Drosophila* development, a large amount of purified *bicoid* mRNA was injected into the posterior end of a wild-type embryo, the resulting developing embryo will have

- (A) normal development with one each of head, thorax and abdomen.
- (B) head in the middle with two thoraces and two abdomens.
- (C) a head with two thoraces and an abdomen.
- (D) two heads and two thoraces with an abdomen segment in the middle.

Q.19 The migratory desert locust, *Schistocerca gregaria*, exists in two mutually exclusive forms: a short-winged, uniformly colored, solitary insect and a long-winged, brightly colored, gregarious morph. These phenotypes depend on crowding. Such phenotypic plasticity is called

- (A) reaction norm.
- (B) polyphenism.
- (C) Batesian mimicry.
- (D) polymorphism.

Q.20 Given below is the list of animals and their respective characteristics.

<i>Animals</i>	<i>Characteristics</i>
I. Sea anemone	i. Three pairs of jointed legs
II. Bluefly	ii. Diploblastic acoelomate
III. Starfish	iii. Collar cells
IV. Sponge	iv. Tube feet

Which ONE of the following represents the correct match?

- (A) I-iv; II-i; III-ii; IV-iii
- (B) I-iii; II-i; III-iv; IV-ii
- (C) I-ii; II-i; III-iv; IV-iii
- (D) I-ii; II-i; III-iii; IV - iv

**END OF THE QUESTION PAPER**

## M: FOOD TECHNOLOGY

### Q. 1 – Q. 10 carry one mark each.

- Q.1 Bread staling is caused by \_\_\_\_\_.
- (A) Caramelisation (B) Gelatinisation  
(C) Retrogradation (D) Aggregation
- Q.2 The grades of tea in the increasing order of their leaf size are \_\_\_\_, \_\_\_\_ and \_\_\_\_ .
- (A) Souchang, pekoe and orange pekoe  
(B) Pekoe, souchang and orange pekoe  
(C) Orange pekoe, souchang, and pekoe  
(D) Orange pekoe, pekoe, and souchang
- Q.3 Fruit juice is being pasteurized in a tubular heat exchanger. The retention time in holding tube of 0.2 m<sup>2</sup> cross sectional area is 3 seconds. If the flow rate of juice is 0.4 m<sup>3</sup> s<sup>-1</sup>, the length of the holding tube in m, is \_\_\_\_\_ .
- Q.4 The oil, which experiences flavor reversion even at the lower peroxide value is \_\_\_\_\_.
- (A) Mustard (B) Soybean  
(C) Palm (D) Sesame
- Q.5 80 kg of wheat containing 10 kg of moisture has been dried to a moisture content of 8% wet basis in 3 hours under constant rate period of drying. The drying rate in kg h<sup>-1</sup> is \_\_\_\_\_
- Q.6 The rate of cream separation in a disc bowl centrifuge can be increased by \_\_\_\_\_ .
- (A) Increasing the size of the bowl (B) Lower viscosity of fluid  
(C) Increasing RPM of the bowl (D) All of these
- Q.7 Rigor mortis is caused due to \_\_\_\_\_ .
- (A) Unavailability of ATP which is necessary to break the link between actin and myosin  
(B) Rupturing of tissue due to unavailability of oxygen  
(C) Decrease in body temperature  
(D) Breakage of rigid protein molecules in sarcoplasm
- Q.8 Oxygen is permeating through an EVOH film of thickness 't' and solubility coefficient 'S'. If diffusivity of oxygen through the film is 'D', then permeability of oxygen through the film will be \_\_\_\_\_
- (A) D/t (B) D/S (C) D × S (D) S/D

- Q.9 Condensing steam is used to heat vegetable oil in a double pipe co-current heat exchanger. If the inlet and outlet temperature of steam are  $T_{hi}$  and  $T_{ho}$ , and for vegetable oil  $T_{ci}$  and  $T_{co}$  respectively, the log mean temperature difference ( $\Delta T_{LM}$ ) will be \_\_\_\_\_ .

(A)  $\frac{T_{hi} - T_{co}}{\ln \frac{T_{hi} - T_{ci}}{T_{hi} - T_{co}}}$  (B)  $\frac{(T_{ho} - T_{co}) - (T_{hi} - T_{co})}{\ln \frac{T_{ho} - T_{ci}}{T_{ho} - T_{co}}}$

(C)  $\frac{(T_{hi} - T_{co}) - (T_{ho} - T_{ci})}{\ln \frac{T_{hi} - T_{ci}}{T_{ho} - T_{co}}}$  (D)  $\frac{T_{co} - T_{ci}}{\ln \frac{T_{hi} - T_{ci}}{T_{hi} - T_{co}}}$

- Q.10 To produce Blue veined cheese, the curd is inoculated with strains of \_\_\_\_\_.

(A) *Propionibacterium shermanii* (B) *Penicillium roqueforti*  
(C) *Penicillium camemberti* (D) *Brevibacterium linens*

**Q. 11 – Q. 20 carry two marks each.**

- Q.11 Match the food spoilage organisms given in Column I with the associated foods given in Column II

**Column I**

P. *Clostridium botulinum*  
Q. *Salmonella spp.*  
R. *Vibrio parahaemolyticus*  
S. *Bacillus cereus*

**Column II**

1. Fish  
2. Cooked starch foods  
3. Meat, egg and poultry  
4. Canned foods

(A) P-4, Q-3, R-1, S-2 (B) P-3, Q-4, R-2, S-1  
(C) P-2, Q-1, R-3, S-4 (D) P-4, Q-3, R-2, S-1

- Q.12 Fluid is flowing inside a pipe of radius 'R' in fully developed laminar flow. If the velocity of the fluid at the centre at a distance 'L' is ' $v_{max}$ ', velocity at radial distance of  $\frac{3}{4}$  (R) will be \_\_\_ times  $v_{max}$

(A) 9/16 (B) 7/16 (C) 16/9 (D) 16/7

- Q.13 The amount of sugar to be added (kg) to 40 kg of mango pulp to increase its total soluble solids from 20% wt. to 65% wt. is \_\_\_\_\_

- Q.14 a) **Assertion:** Acidulates are added in soft drinks to provide a buffering action.  
r) **Reason:** Buffers tend to prevent changes in pH and prevent excessive tartness.  
Choose the correct answer from the following

(A) Both a) and r) are true but r) is not the correct reason  
(B) Both a) and r) are true and r) is the correct reason for a)  
(C) a) is true but r) is false  
(D) Both a) and r) are false

Q.15 The  $D_{121}$  and  $Z$  values for *C. botulinum* spores in canned food are 0.2 min and 10 °C, respectively. Total time required in min, to reduce the spores from  $10^2$  to  $10^{-6}$  at 111 °C is \_\_\_\_\_ .

Q.16 In a typical Psychrometric Chart shown below, the processes OP, OQ and OR related to air water vapor mixture are \_\_\_\_\_, \_\_\_\_\_ and \_\_\_\_\_.

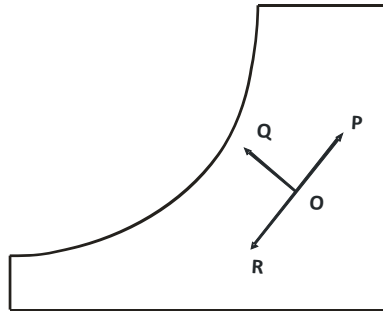

- (A) Cooling & dehumidification, cooling & humidification, heating & humidification
- (B) Cooling & dehumidification, heating & humidification, drying
- (C) Heating & humidification, cooling & humidification, cooling & dehumidification
- (D) Heating & humidification, cooling & dehumidification, drying

Q.17 Match the enzymes in Column I with their functions in Column II

**Column I**

- P. Amylase
- Q. Invertase
- R. Phosphatase
- S. Protease

**Column II**

1. Conversion of sucrose to glucose and fructose
2. Softening of dough
3. Effectiveness of pasteurization
4. Conversion of starch to maltose

- (A) P-1, Q-2, R-3, S-4
- (C) P-1, Q-4, R-2, S-3

- (B) P-4, Q-1, R-3, S-2
- (D) P-2, Q-4, R-3, S-1

Q.18 Match the terms in Column I with their most appropriate description in Column II

**Column I**

- P. Enrichment
- Q. Fortification
- R. Supplementation
- S. Complementation

**Column II**

1. Overcome the deficiency of nutrients by mixing of two plant sources
2. Overcome the deficiency of nutrients from a synthetic source
3. Restoration of nutrients which are lost during processing
4. Addition of nutrients which may or may not originally present

- (A) P-3, Q-4, R-2, S-1
- (C) P-1, Q-2, R-3, S-4

- (B) P-4, Q-3, R-1, S-2
- (D) P-2, Q-3, R-1, S-4

Q.19 Match the products in Column I with their Original Phase in Column II

**Column I**

- P. Milk
- Q. Butter
- R. Lactose
- S. Casein

**Column II**

1. Colloidal
2. Solution
3. Water in oil emulsion
4. Oil in water emulsion

- (A) P-3, Q-4, R-1, S-2
- (C) P-4, Q-3, R-2, S-1

- (B) P-3, Q-4, R-2, S-1
- (D) P-4, Q-3, R-1, S-2

- Q.20 a) **Assertion:** Presence of low sulphur containing amino acids makes casein in milk to boil, sterilize and concentrate without coagulation even at higher temperatures.  
r) **Reason:** This is due to the restricted formation of di-sulphide bonds resulting in increased stability.

Choose the correct answer from the following

- (A) Both a) and r) are true and r) is the correct reason for a)
- (B) Both a) and r) are true but r) is not the correct reason for a)
- (C) Both a) and r) are false
- (D) a) is true but r) is false

**END OF THE QUESTION PAPER**

Q. No	Type	Section	Key	Marks
1	MCQ	GA	C	1
2	MCQ	GA	B	1
3	MCQ	GA	B	1
4	MCQ	GA	B	1
5	MCQ	GA	C	1
6	NAT	GA	120 : 120	2
7	MCQ	GA	C	2
8	MCQ	GA	C	2
9	MCQ	GA	A	2
10	NAT	GA	7.0 : 7.0	2
1	MCQ	XL-H	A	1
2	NAT	XL-H	4.0 : 4.0	1
3	MCQ	XL-H	B	1
4	MCQ	XL-H	D	1
5	MCQ	XL-H	B	1
6	MCQ	XL-H	D	2
7	NAT	XL-H	13.55 : 13.64	2
8	NAT	XL-H	0.52 : 0.54	2
9	MCQ	XL-H	D	2
10	NAT	XL-H	4 : 4	2
11	MCQ	XL-H	C	2
12	NAT	XL-H	180 : 182	2
13	MCQ	XL-H	A	2
14	NAT	XL-H	0.22 : 0.24	2
15	NAT	XL-H	-105 : -102	2
1	MCQ	XL-I	A	1
2	NAT	XL-I	1.20 : 1.24	1
3	MCQ	XL-I	D	1
4	MCQ	XL-I	C	1
5	MCQ	XL-I	B	1
6	MCQ	XL-I	D	1
7	MCQ	XL-I	A	1
8	MCQ	XL-I	A	1
9	MCQ	XL-I	B	1
10	MCQ	XL-I	D	1
11	MCQ	XL-I	B	2
12	MCQ	XL-I	C	2
13	MCQ	XL-I	A	2
14	NAT	XL-I	10 : 11	2
15	MCQ	XL-I	A	2
16	MCQ	XL-I	C	2
17	MCQ	XL-I	C	2
18	MCQ	XL-I	B	2
19	MCQ	XL-I	D	2
20	MCQ	XL-I	C	2
1	MCQ	XL-J	C	1
2	MCQ	XL-J	B	1
3	MCQ	XL-J	C	1
4	MCQ	XL-J	B	1



5	MCQ	XL-J	D	1
6	MCQ	XL-J	B	1
7	MCQ	XL-J	A	1
8	MCQ	XL-J	D	1
9	MCQ	XL-J	C	1
10	MCQ	XL-J	D	1
11	MCQ	XL-J	A	2
12	MCQ	XL-J	B	2
13	MCQ	XL-J	D	2
14	MCQ	XL-J	D	2
15	MCQ	XL-J	A	2
16	MCQ	XL-J	A	2
17	MCQ	XL-J	B	2
18	MCQ	XL-J	B	2
19	MCQ	XL-J	B	2
20	MCQ	XL-J	B	2
1	MCQ	XL-K	A	1
2	MCQ	XL-K	B	1
3	MCQ	XL-K	C	1
4	MCQ	XL-K	B	1
5	MCQ	XL-K	C	1
6	MCQ	XL-K	D	1
7	MCQ	XL-K	A ; D	1
8	MCQ	XL-K	A	1
9	NAT	XL-K	2.0 : 2.0	1
10	NAT	XL-K	375 : 375	1
11	MCQ	XL-K	C	2
12	MCQ	XL-K	B	2
13	MCQ	XL-K	A	2
14	NAT	XL-K	2.4 : 2.4	2
15	MCQ	XL-K	D	2
16	MCQ	XL-K	B	2
17	NAT	XL-K	1.0 : 1.0	2
18	NAT	XL-K	0.10 : 0.11	2
19	MCQ	XL-K	D	2
20	MCQ	XL-K	C	2
1	MCQ	XL-L	C	1
2	MCQ	XL-L	D	1
3	MCQ	XL-L	C	1
4	MCQ	XL-L	A	1
5	MCQ	XL-L	A	1
6	MCQ	XL-L	D	1
7	MCQ	XL-L	A	1
8	MCQ	XL-L	B	1
9	MCQ	XL-L	C	1
10	MCQ	XL-L	B	1
11	MCQ	XL-L	A	2
12	MCQ	XL-L	B	2
13	MCQ	XL-L	D	2
14	MCQ	XL-L	D	2

15	MCQ	XL-L	C	2
16	MCQ	XL-L	A	2
17	MCQ	XL-L	B	2
18	MCQ	XL-L	D	2
19	MCQ	XL-L	B	2
20	MCQ	XL-L	C	2
1	MCQ	XL-M	C	1
2	MCQ	XL-M	A	1
3	NAT	XL-M	5.9 : 6.1	1
4	MCQ	XL-M	B	1
5	NAT	XL-M	1.3 : 1.4	1
6	MCQ	XL-M	D	1
7	MCQ	XL-M	A	1
8	MCQ	XL-M	C	1
9	MCQ	XL-M	D	1
10	MCQ	XL-M	B	1
11	MCQ	XL-M	A	2
12	MCQ	XL-M	B	2
13	NAT	XL-M	51 : 52	2
14	MCQ	XL-M	B	2
15	NAT	XL-M	15 : 17	2
16	MCQ	XL-M	C	2
17	MCQ	XL-M	B	2
18	MCQ	XL-M	A	2
19	MCQ	XL-M	C	2
20	MCQ	XL-M	A	2

Please visit: [www.easybiologyclass.com](http://www.easybiologyclass.com) for:

- **Lecture Notes**
- **Biology PPTs**
- **Biology MCQs**
- **Online Mock Tests (MCQ)**
- **Practical Aids**
- **Model Question Papers of NET, GATE, DBT, ICMR Exams**
- **CSIR NET Life Sciences Previous Year Question Papers**
- **GATE Previous Year Question Papers**
- **DBT BET JRF Previous Year Question Papers**
- **ICMR JRF Entrance Exam Resources**
- **Higher Scondary Biology Resources**
- **Jobs Notifications**
- **Higher Studies in Biology / Life Sciences**
- **Seminar / Workshop/ Conference Notifications**
- *And many more....*



**EASY BI●OLOGY CLASS**

● Biology Made Easy ●