



Previous Year Question Paper  
of

**AIIMS**

**MBBS Entrance Examination**

**AIIMS: 2002**

*(Original Question Paper with Answer Key)*  
All India Institute of Medical Sciences, New Delhi

Download PDF Now!



For more question papers, please visit: [www.easybiologyclass.com](http://www.easybiologyclass.com)

Max. Time :  $3\frac{1}{2}$  hrs.

Max. Marks : 200

**PHYSICS****1. One nanometre is equal to**

- (1)  $10^{-7}$  cm            (2)  $10^{-9}$  cm  
 (3)  $10^{-9}$  cm            (4)  $10^9$  mm

**2. Density of wood is 0.5 kg /cc in the CGS system of units. The corresponding value in MKS units is**

- (1) 5000    (2) 0.5    (3) 5    (4) 500

**3. A body is moving from rest under constant acceleration and  $S_1$  be the displacement in the first (p - 1) sec and  $S_2$  be the displacement in the next p sec. The displacement in  $(p^2 - p + 1)^{\text{th}}$  sec will be**

- (1)  $S_1/S_2$                     (2)  $S_1 - S_2$   
 (3)  $S_1 S_2$                     (4)  $S_1 + S_2$

**4. A stone of mass m is tied to a string of length l and rotated in a circle with a constant speed v. If the string is released, the stone flies**

- (1) Tangential outward  
 (2) Radically outward    (3) Radially inward  
 (4) With an acceleration  $\frac{mv^2}{l}$

**5. The horizontal range is four times the maximum height attained by a projectile. The angel of projectile is**

- (1)  $30^\circ$     (2)  $45^\circ$     (3)  $90^\circ$     (4)  $60^\circ$

**6. With what minimum acceleration can a firemen slides down a rope while breaking strength of the rope is  $\frac{2}{3}$  his weight**

- (1)  $\frac{1}{3}g$     (2)  $\frac{2}{3}g$     (3) Zero    (4) g

**7. A rough vertical board has an acceleration 'a' so that a 2 kg block pressing****against it does not fall. The coefficient of friction between the block and the board should be**

- (1)  $< \frac{a}{g}$   
 (2)  $= \frac{g}{a}$   
 (3)  $> \frac{a}{g}$   
 (4)  $> \frac{g}{a}$

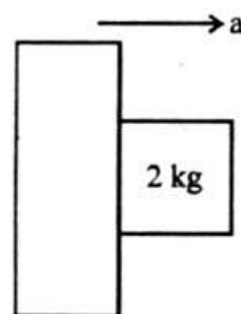
**8. Which of the following statements is true**

- (1) Total kinetic energy is conserved in elastic collisions but momentum is not conserved in elastic collisions  
 (2) Total kinetic energy is not conserved but momentum is conserved in inelastic collisions  
 (3) In elastic collisions, the momentum is conserved but not in inelastic collisions  
 (4) Both kinetic energy and momentum are conserved in elastic as well as inelastic collisions

**9. A hollow cylinder and a solid cylinder having the same mass and same diameter are released from rest simultaneously from the top of an inclined plane. Which will reach the bottom first**

- (1) The hollow cylinder  
 (2) The solid cylinder  
 (3) The one having greater density  
 (4) Both will reach the bottom together

**10. If a body describes a circular motion under inverse square field, the time taken to complete one revolution T is related to the radius of the circular orbit as**

- (1)  $T \propto r^4$                       (2)  $T^2 \propto r^3$   
 (3)  $T \propto r^2$                       (4)  $T \propto r$

**11. The earth revolves about the sun in an elliptical orbit with mean radius  $9.3 \times 10^7$  m in a period of 1 year. Assuming that there are no outside influences**

- (1) The earth's kinetic energy remains constant  
 (2) The earth's potential energy remains constant  
 (3) The earth's angular momentum remains constant  
 (4) (1), (2) and (3) are correct

**12. Calculate the work done, if a wire is loaded by 'Mg' weight and the increase in length is 'l'**

- (1)  $Mgl/2$     (2)  $2 Mgl$     (3)  $Mgl$     (d) zero

**13. A spherical ball contracts in volume by 0.01 % when subjected to a normal uniform pressure of 100 atmospheres. The bulk modulus of its material in  $\text{dyne/cm}^2$  is**

- (1)  $2.0 \times 10^{11}$                       (2)  $1 \times 10^{12}$   
 (3)  $100 \times 10^{12}$                       (4)  $10 \times 10^{12}$

**14. More liquid rises in a thin tube because of**

- (1) Smaller value of radius  
 (2) Smaller value of surface tension  
 (3) Larger value of radius  
 (4) Larger value of surface tension

**15. Which statement is false ?**

- (1) The gas pressure per unit volume is  $2/3$  of the mean kinetic energy  
 (2) In a perfect gas, there is no force of attraction among the molecules  
 (3) The RMS velocity of the gas molecules is proportional to its absolute temperature\*  
 (4) The RMS velocity of the gas molecules is inversely proportional to the square root of the molecular weight.

**16. If the universal gas constant is R and Boltzmann constant is K, then number**

**of molecules in a mol of hydrogen will be**

- (1)  $K/R$     (2)  $R/2K$     (3)  $R/K$     (4)  $2R/K$

**17. A solid cylinder of mass 20 kg is turned by 50 W motor against a friction band. After 4 minutes, the temperature rises from  $20^\circ\text{C}$  to  $30^\circ\text{C}$ . The specific heat capacity of the material of the cylinder is**

- (1) 600 J/kg                      (2) 200 J/kg  
 (3) 150 J/kg                      (4) 10 J/kg

**18. A gas expands under constant pressure P from volume  $V_1$  to  $V_2$ . The work done by the gas is**

- (1)  $P \frac{V_1 V_2}{V_2 - V_1}$                       (2)  $P (V_1 - V_2)$   
 (3)  $P (V_1 - V_2)$                       (4)  $P (V_2 - V_1)$

**19. In isothermal expansion, the pressure is determined by**

- (1) Compressibility only  
 (2) Temperature only  
 (3) Both temperature and compressibility  
 (4) None of these

**20. Two identical plates of different metals are joined to form a single plate whose thickness is double the thickness of each plate. If the coefficients of conductivity of each plate are 2 and 3 respectively, then the conductivity of composite plate will be**

- (1) 5    (2) 1.2    (3) 2.4    (4) 1.5

**21. A spring has force constant K and a mass m is suspended from it. The spring is cut in half and the same mass is suspended from one of the halves. If the frequency of oscillation in the first case is  $\alpha$ , then the frequency in the second case will be**

- (1)  $\alpha\sqrt{2}$     (2)  $\alpha/2$     (3)  $\alpha$     (4)  $2\alpha$

**22. The motion of a particle varies with time according to the relation  $y = a (\sin \omega t + \cos \omega t)$ , then**

- (1) The motion is S.H.M. with amplitude  $2a$   
 (2) The motion is S.H.M. with amplitude  $a\sqrt{2}$

(3) The motion is S.H.M. with amplitude  $a$

(4) The motion is oscillatory but not S.H.M.

**23. Equation of a progressive wave is given by**

$$y = 0.2 \cos \pi \left( .04t + .02x - \frac{\pi}{6} \right). \text{ The distance is expressed in cm and time in second. What will be the minimum distance between two particles having the phase difference of } \pi/2$$

(1) 12.5 cm (2) 25 cm  
(3) 8 cm (4) 4 cm

**24. A tuning fork of frequency 480 Hz produces 10 beats per second when sounded with a vibrating sonometer string. What must have been the frequency of the string if a slight increase in tension produces fewer beats per second than before**

- (1) 490 Hz (2) 480 Hz  
(4) 470 Hz (4) 460 Hz

**25. The figures shown a double slit experiment and Q are the slits. The path length PX and QX are  $n\lambda$  and  $(n+2)\lambda$  respectively, where  $n$  is a whole number and  $\lambda$  is the wavelength. Taking the central fringe as zero, what is formed at X ?**

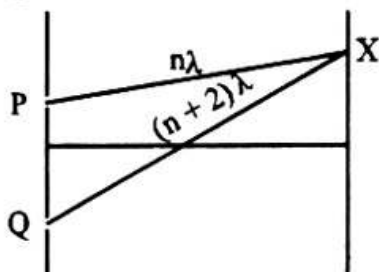

- (1) Second dark (2) Second bright  
(3) First dark (4) First bright

**26. A star is moving away from the earth with a velocity 100 km/s. . If the velocity of light is  $3 \times 10^8$  m/s, then the shift of its spectral line of wavelength 5700 Å due to Doppler's effect will be**

- (1) 0.63 Å (2) 3.80 Å  
(3) 1.90 Å (4) 5.70 Å

**27. The width of the spectrum obtained by prism does not depend upon**

- (1) Angle of the prism  
(2) Incident angle (3) Angular dispersion  
(4) Material of the prism.

**28. The condition that the image is not formed on the screen placed on the other side of lens, when the object is placed before the lens**

- (1) Between 2F and F  
(2) Between F and optical centre  
(3) Between 2F and infinity  
(4) At F

**29. A person suffering from hypermetropia requires which type of spectacle lenses**

- (1) Convex lens  
(2) Convex-concave lens  
(3) Plano-concave lens  
(4) Concave lens

**30. If the focal length of objective and eye lens are 1.2 cm and 3 cm respectively and the object is put 1.25 cm away from the objective lens and the final image is formed at infinity. The magnifying power of the microscope is**

- (1) 400 (2) 250 (3) 200 (4) 150

**31. A radio or T.V. set which uses valves does not start operating immediately when it switched on, whereas the set only containing transistors operates immediately. The reason for this is that**

- (1) Current does not have so far to go in a transistor set  
(2) Filament of the valve takes time to heat up  
(3) Valve set works at a higher voltage  
(4) Transistor set has a lower resistance.

**32. If the distance between two similar magnetic poles held one cm apart be doubled, then the force of interaction between them will be**

- (1) Halved  
(2) Doubled (3) Unchanged  
(4) One quarter of the original value

**33. The dipole moment of a short bar magnet is  $1.25 \times \text{ampere} - \text{metre}^2$ . The magnetic field on its axis at a distance of 0.5 metre from the centre of the magnet is**

- (1)  $6.64 \times 10^{-8}$  newton/amp - metre
- (2)  $2 \times 10^{-6}$  newton/amp - metre
- (3)  $1.0 \times 10^{-4}$  newton/amp - metre
- (4)  $4 \times 10^{-2}$  newton/amp - metre

**34. The electric field due to a dipole at a distance  $r$  from its axis is**

- (1) Inversely proportional to  $r^2$
- (2) Directly proportional to  $r^2$
- (3) Inversely proportional to  $r^3$
- (4) Directly proportional to  $r^3$

**35. The capacity of parallel plate condenser depends on**

- (1) The potential applied across the plates
- (2) The separation between the plates
- (3) The type of metal used
- (4) The thickness of plates

**36. A capacitor of capacity  $C$  has charge  $Q$  and stored energy is  $W$ . If the charge is increased to  $2Q$ , the stored energy will be**

- (1)  $W/4$
- (2)  $4W$
- (3)  $W/2$
- (4)  $2W$

**37. Two metallic charged spheres whose radii are 20 cm and 10 cm respectively,**

**have each 150 micro-coulomb positive charge. The common potential after they are connected by a conducting wire is**

- (1)  $13.5 \times 10^6$  volts
- (2)  $1.8 \times 10^7$  volts
- (3)  $4.5 \times 10^6$  volts
- (4)  $9 \times 10^6$  volts

**38. The reading of the ammeter as per figure shown is**

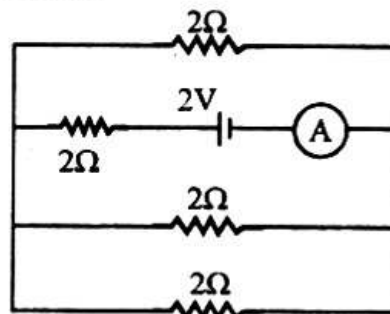

- (1)  $\frac{1}{2}$  A
- (2)  $\frac{1}{8}$  A
- (3)  $\frac{3}{4}$  A
- (4) 2A

**39. In an electrolyte  $3.2 \times 10^{18}$  bivalent positive ions drift to the right per second while  $3.6 \times 10^{18}$  monovalent negative ions drift to the left per second. Then the current is**

- (1) 0.45 amp to the left
- (2) 0.45 to the right
- (3) 1.6 amp to the right
- (4) 1.6 amp to the left

**40. A metallic wire of 40 ohms resistance will be**

- (1) 320 ohms
- (2) 320 ohms
- (3) 160 ohms
- (4) 20 ohms

## ASSERTION AND REASONING

§ **Directions for Q 41 to 60. These questions consist of two statements each, printed as Assertion and Reason. While answering these questions you are required to choose any one of the following four responses.**

1. If both the Assertion and Reason are true and the Reason is a correct explanation of the Assertion.
2. If both the Assertion and Reason are true but the Reason is not a correct explanation of the Assertion.
3. If the Assertion is true but the Reason is false.
4. If the Assertion is false but the Reason is true.

41. **Assertion** : Quasar emits radio waves more than radio galaxy.

**Reason**: Quasar has very small size.

42. **Assertion** : When a tiny circular obstacle is placed in the path of light from some distance, a bright spot is seen at the centre of the shadow of the obstacle.

- (1) (2) (3)

**Reason**: Destructive interference occurs at the centre of the shadow.

- (4)

43. **Assertion** : The quantity  $L/R$  possesses dimension of time

- (1) (2) (3)

**Reason**: To reduce the rate of increase of current through a solenoid, we should increase the time constant ( $L/R$ ).

- (4)

44. **Assertion** : Faraday's laws are consequence of conservation of energy.

- (1) (2) (3)

**Reason**: In a purely resistive A.C. circuit, the current lags behind the e.m.f. in phase.

- (4)

45. **Assertion** : Blue star is at higher temperature than red star.

- (1) (2) (3)

**Reason**: Wein's displacement law states that

$$T \propto \frac{1}{\lambda_m}$$

- (4)

46. **Assertion** : In an elastic collision of two billiard balls, the total K.E. is conserved during the short time of collision of the ball (i.e., when they are in contact.)

- (1) (2) (3)

**Reason**: Energy spent against friction follows the law of conservation of energy.

- (4)

47. **Assertion** : The  $v-t$  graph perpendicular to the time axis is not possible.

- (1) (2) (3)

**Reason**: If  $v-t$  graph is perpendicular to the time axis, the velocity of the particle should be infinite.

- (4)

48. **Assertion**: The time rate of change of speed in one dimensional motion depends on the instantaneous velocity.

- (1) (2) (3)

**Reason**: Speed = Magnitude of velocity.

- (4)

49. **Assertion**: The co-efficient of apparent expansion can be negative.

- (1) (2) (3)

**Reason**: Co-efficient of real expansion of a liquid can be less than the co-efficient of expansion of vessel.

- (4)

50. **Assertion**: Two different but ideal gases at the same temperature have equal root mean square speed of molecules.

- (1) (2) (3)

**Reason**: Root mean square speed of molecules is given by:  $c = \sqrt{\frac{3RT}{M}}$

- (4)

51. **Assertion**: The infrasonic waves propagate with different speeds.

- (1) (2) (3)

**Reason**: Velocity of sound = [ Modulus of elasticity/Density of medium]<sup>1/2</sup>.

- (4)

52. **Assertion:** The magnetic field at the centre of the circular coil in the following figure is zero.

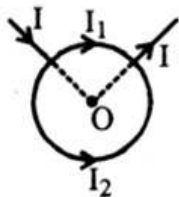

- (1) (2) (3)
53. **Assertion:** The average value of alternating emf is 63.66% of the peak value.  
(1) (2) (3)
54. **Assertion:** When a person moves towards the mirror with speed  $c$ , his image approaches him with speed  $2c$ .  
(1) (2) (3)
55. **Assertion:** An observer looks at a tree of height 15cm. with a telescope of magnifying power 10. To him the tree appears to be of length 150m.  
(1) (2) (3)
56. **Assertion:** A deuteron and an  $\alpha$  - particle enter the same magnetic field with the same velocity, the radius of their circular paths will be same.  
(1) (2) (3)
57. **Assertion:** Coloured spectrum is seen when we look through a muslin cloth.  
(1) (2) (3)
58. **Assertion:** In a simple battery circuit, the point of the lowest potential is positive terminal of the battery.  
(1) (2) (3)
59. **Assertion:** The flash of lightening is seen before the sound of thunder is heard.  
(1) (2) (3)
60. **Assertion:** The time-period of pendulum, on a satellite orbiting the earth is infinity.  
(1) (2) (3)

**Reason :**  $B = \frac{\mu_0}{4\pi} \frac{I}{R^3} l$  Where  $I$  = current,  $l$  =

Length of the arc,  $R$  = radius of the arc.  $I_1 = I_2$ , therefore the magnetic field due to one part balances that due to the other part of the circle.

- (4)
- Reason :** The rms value of alternating emf is 70.71% of peak value  
(4)

**Reason :** Image is as far behind the mirror as the object is in front of the mirror.  
(4)

**Reason :** Magnifying power of telescope is the ratio of the angle subtended by the image to that subtended by the object.  
(4)

**Reason :** Radius of circular path is directly proportional to the momentum of the particle.  
(4)

**Reason :** It is due to the diffraction of white light on passing through fine slits.  
(4)

**Reason :** The current flows towards the point of the lower potential, as it does in such a circuit from the positive to the negative terminal.  
(4)

**Reason :** Speed of sound is greater than speed of light.  
(4)

**Reason :** Time-period of a pendulum is inversely proportional to  $\sqrt{g}$ .  
(4)

## ANSWERS

- 1.(1). 2.(4). 3.(4). 4.(1). 5.(2). 6.(1). 7.(4). 8.(2). 9.(2). 10.(2) 11.(3).  
 12.(1). 13.(2). 14.(1). 15.(3). 16.(3). 17.(1). 18.(4). 19.(1). 20.(3).  
 21.(1). 22.(2). 23.(2). 24.(3). 25.(2). 26.(3). 27.(2). 28.(4). 29.(1).  
 30.(3). 31.(2). 32.(4). 33.(2). 34.(3). 35.(3). 36.(2). 37.(4). 38.(3).  
 39.(3). 40.(3). 41.(2). 42.(3). 43.)C). 44.(3). 45.(1). 46.(4). 47.(2).  
 48.(4). 49.(1). 50.(4). 51.(4). 52.(3). 53.(2). 54.(1). 55.(4). 56.(2).  
 57.(1). 58.(4). 59.(3). 60.(1).

## HINTS & EXPLANATIONS

1. Ans. (1)  $1 \text{ nm} = 10^{-9} \text{ m} = 10^{-7} \text{ cm}$

2. Ans. (4)  $1 \text{ CGS} = 1000 \text{ MKS}$

$\Rightarrow 0.5 \times 1000 = 500 \text{ kg/m}^3$

3. Ans. (4)

$$S = \frac{1}{2} f [(p^2 - p + 1)^2 - (p^2 - p)^2]$$

$$= \frac{1}{2} f [(2p^2 - 2p + 1)]$$

$$S_1 = \frac{1}{2} f [(p - 1)^2]$$

$$= \frac{1}{2} f [p^2 - 2p + 1]$$

$$S_2 = \frac{1}{2} f \cdot p^2$$

$$\therefore S_1 + S_2 = \frac{1}{2} f [2p^2 - 2p + 1]$$

$$\therefore S = S_1 + S_2$$

4. Ans. (1) In the circular motion, direction of velocity always remains tangential to the circle.

5. Ans. (2)

$$\text{Given } \frac{u^2 \sin 2\theta}{g} = 4 \left( \frac{u^2 \sin^2 \theta}{2g} \right)$$

$$\Rightarrow 2 \sin \theta \cos \theta = 2 \sin^2 \theta$$

$$\Rightarrow \tan \theta = 1 \Rightarrow \theta = 45^\circ$$

6. Ans. (1) The acceleration on the man and rope is due to 'g' of the earth

The acceleration on the rope due to its own weight =  $\frac{2}{3}g$

The minimum acceleration produced by man =  $g - \frac{2}{3}g = \frac{1}{3}g$

7. Ans. (4) The force exerted on 2 kg body =  $2a$

$\therefore$  Normal reaction =  $2a$

the force of friction acting up ward =  $2\mu a$

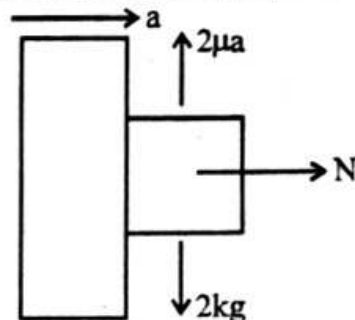

If this is not to fall,  $2\mu a > 2g \Rightarrow \mu > \frac{g}{a}$

8. Ans. (2) Total kinetic energy is not conserved but momentum is conserved in inelastic collisions

9. Ans. (2) It will have smaller moment of inertia.

10. Ans. (2) Kepler's law

11. Ans. (3) In elliptical orbit the distance of the earth from the sun changes i.e. potential energy changes. But the total energy remains constant, so kinetic energy also changes. In



elliptical orbit the area swept per unit time remains constant.

$$\frac{1}{2} r^2 \frac{d\theta}{dt} = K$$

$$\Rightarrow \frac{1}{2} \omega r^2 = K \Rightarrow m\omega r^2 = K$$

i.e. angular momentum remains constant

12. Ans. (1)

$$\text{Total W.D.} = \frac{1}{2} \times \text{Stress} \times \text{Strain} \times \text{Volume}$$

$$= \frac{1}{2} \times \frac{Mg}{A} \times \frac{l}{L} \times AL = \frac{1}{2} Mg l$$

13. Ans. (2)

$$K = P \left( \frac{V}{v} \right), 1 \text{ atm.} = 10^5 \text{ pascal} = 10^5 \text{ N/m}^2$$

$$\therefore K = 100 \left( \frac{100}{0.01} \right) = 1 \times 10^{12} \text{ dyne/cm}^2$$

14. Ans. (1)  $T = \frac{r h p g}{2 \cos \theta}$

Other factors remaining same,  $rh = \text{constant}$   
 $\Rightarrow$  Smaller the radius, the more liquid will rise.

15. Ans. (3)  $v_{\text{rms}} = \sqrt{\frac{3RT}{M}}$

16. Ans. (3) Since  $K = \frac{R}{N}$

17. Ans. (1) since  $mC_q = \Delta Q$ ,  
 where  $C_q$  is specific heat capacity

$$\Rightarrow C_q = \frac{\Delta Q}{m}$$

$$= \frac{50 \times 4 \times 60}{20} = 600 \text{ J/kg}$$

18. Ans. (4) Work done =  $PdV = P(V_2 - V_1)$

19. Ans. (1) For such a case,

$$\text{pressure} = \frac{1}{\text{compressibility}}$$

20. Ans. (3) Rate of heat flow for such a wall can be given as

$$\frac{A(\theta_1 - \theta_2)}{\frac{d_1}{K_1} + \frac{d_2}{K_2}} = \frac{A(\theta_1 - \theta_2) \times K_{\text{equivalent}}}{d_1 + d_2}$$

$$\therefore d_1 = d_2 = d$$

$$\therefore \frac{d}{K_1} + \frac{d}{K_2} = \frac{2d}{K}$$

$$\Rightarrow \frac{1}{K_1} + \frac{1}{K_2} = \frac{2}{K}$$

$$\Rightarrow \frac{1}{2} + \frac{1}{3} = \frac{2}{K}$$

$$\Rightarrow K = 2 \times \frac{6}{5} = 2.4$$

21. Ans. (1)  $\frac{T_2}{T_1} = \frac{1}{\sqrt{2}}$

$$\Rightarrow \frac{F_1}{F_2} = \frac{T_2}{T_1} = \frac{1}{\sqrt{2}}$$

$$\Rightarrow \frac{\alpha}{F_2} = \frac{1}{\sqrt{2}} \Rightarrow F_2 = \alpha\sqrt{2}$$

22. Ans. (2)  $y = a(\cos \omega t + \sin \omega t) = a\sqrt{2}$

$$\left[ \frac{1}{\sqrt{2}} \cos \omega t + \frac{1}{\sqrt{2}} \sin \omega t \right]$$

$$= a\sqrt{2} [\sin 45^\circ \cos \omega t + \cos 45^\circ \sin \omega t]$$

$$= a\sqrt{2} \sin(\omega t + 45^\circ)$$

$\therefore$  Amplitude =  $a\sqrt{2}$

23. Ans. (2) Comparing with

$$y = A \cos \frac{2\pi}{\lambda} (vt - x + \phi)$$

We have  $\frac{2\pi}{\lambda} = 0.02\pi$

We know that  $\frac{2\pi}{\lambda} \times \text{path difference} = \text{phase difference}$

$$\Rightarrow \text{Path difference} = \frac{\pi/2}{0.02\pi} \text{ cm} = 25 \text{ cm}$$

24. Ans. (3)  $480 - 10 = 470 \text{ Hz}$

25. Ans. (2) For brightness, path difference =  $n\lambda = 2\lambda$

So second is bright.

26. Ans. (3)

$$\Delta\lambda = \lambda \frac{v}{c} = 5700 \times \frac{100 \times 10^3}{3 \times 10^8} = 1.90 \text{ \AA}$$

27. Ans. (2) Since deviation =  $(\mu - 1)A$

28. Ans. (4) In this condition image will be formed at infinity.

29. Ans. (1) Hypermetropia is removed by convex lens.

30. Ans. (3)

$$\frac{1}{f_0} = \frac{1}{u_0} + \frac{1}{v_0} \Rightarrow \frac{1}{v_0} = \frac{1}{1.2} - \frac{1}{1.25}$$

$$\frac{1}{v_0} = \frac{0.05}{1.2 \times 1.25}$$

$$v_0 = 1.2 \times 25 = 30 \text{ cm}$$

Magnifying power

$$= -\frac{v_0}{u_0} \times \frac{D}{f_e} = -\frac{30}{1.25} \times \frac{25}{3} = 200$$

31. Ans. (2) But in case of transistor there is no filament to be heated up.

32. Ans. (4) According to Coulomb's law  $F \propto \frac{1}{r^2}$

$$\Rightarrow \frac{F_2}{F_1} = \frac{r_1^2}{r_2^2} \Rightarrow \frac{F_2}{F_1} = \frac{r_1^2}{(2r_1)^2} = \frac{1}{4}$$

or  $F_2 = \frac{1}{4}F_1$

33. Ans. (2)

$$B = \frac{\mu_0}{4\pi} \frac{2M}{d^2} = 10^{-7} \times \frac{2 \times 1.25}{(0.5)^3}$$

$$= 2 \times 10^{-6} \text{ N/A-m}$$

34. Ans. (3)  $E = \frac{1}{4\pi\epsilon_0} \cdot \frac{P}{r^3}$

35. Ans. (2)  $C = \frac{k\epsilon_0 A}{d}$

36. Ans. (2)  $W = \frac{Q^2}{2C} \Rightarrow W = 4W$

37. Ans. (4)  $\frac{q_1}{4\pi\epsilon_0 r_1} = \frac{q_2}{4\pi\epsilon_0 r_2} = V$

$$\Rightarrow \frac{q_1}{q_2} = \frac{r_1}{r_2} \Rightarrow \frac{q_1 + q_2}{q_2} = \frac{r_1 + r_2}{r_2}$$

$$\therefore q_2 = \frac{qr_2}{r_1 + r_2} = \frac{300 \times 10}{10 + 20} = 100 \mu\text{C}$$

$$\therefore V = \frac{9.0 \times 10^9 \times 100 \times 10^{-6}}{10 \times 10^{-2}} = 9 \times 10^6 \text{ V}$$

38. Ans. (3) Resistance across XY =  $\frac{2}{3} \Omega$

$$\text{Total resistance} = 2 + \frac{2}{3} = \frac{8}{3} \Omega$$

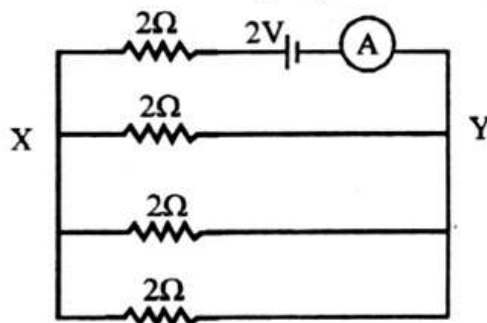

Current (Ammeter reading)

$$= \frac{2 \times 3}{8} = \frac{6}{8} = \frac{3}{4} \text{ ampere}$$

39. Ans. (3)  $i = \frac{\text{Net charge}}{\text{Time}}$

$$= [3.2 \times 10^{18} \times 2 \times 1.6 \times 10^{-19} + 3.6 \times 10^{18} \times 1.6 \times 10^{-19}]$$

to the right

[Since positive charge is more, hence the direction of current is towards right]

$$= 1.6 \times 10^{-1} (6.4 + 3.6) = 1.6 \text{ A}$$

to the right.

40. Ans. (3)  $R \propto l^2$  on stretching a wire, hence four times.

41. (2). A quasar is a very big source of radio waves and its size is very small as compared to the size of a galaxy. A radio galaxy emits radio waves which lie in the range  $10^{30}$  to  $10^{38}$  watt. A quasar emits radio waves which lie in the range of  $10^{37}$  to  $10^{38}$  watt.

42. (3) The waves diffracted from the edges of circular obstacle, places in the path of light, interfere constructively at the centre of the shadow resulting in the formation of a bright spot.

43. (3). Induced e.m.f. ( $\epsilon$ ) =  $\frac{L di}{dt}$

$$\text{and current } (i) = \frac{\epsilon}{R} = \frac{1}{R} \times \frac{L di}{dt} \text{ or}$$

$$\frac{L}{R} = \frac{i \cdot dt}{dt} = \frac{\text{Current} \times \text{Time}}{\text{Current}} = \text{Time}$$

In order to increase the rate of increase of current through a solenoid, we increase the time con-

stant  $\frac{L}{R}$ . Since  $L$  of the given solenoid is constant, therefore we use a high resistance in series with it.

- 44.** (3). Faraday's laws involve conservation of mechanical energy into electrical energy. This is in accordance with the law of conservation of energy. In pure resistance, the e.m.f. is in phase with the current.
- 45.** (1). According to Wein's displacement law, temperature  $(T) \propto \frac{1}{\lambda_m}$  (where  $\lambda_m$  is the maximum wavelength). Thus temperature of a body is inversely proportional to the wavelength. Since Blue star has smaller wavelength and Red Star has maximum wavelength, therefore Blue Star is at higher temperature than Red Star.
- 46.** (4). The billiard balls in an elastic collision are in contact, they are in a deformed state. And their total energy is in the form of P.E. and K.E. is less than the total energy. The energy spent against friction is dissipated in the form of heat which is not available for doing work.
- 47.** (2). Velocity-time ( $v - t$ ) graph perpendicular to the time axis is not possible because it requires infinite acceleration.
- 48.** (4). The time rate of change of speed in one dimensional motion is magnitude of acceleration and it is independent of instantaneous velocity.
- 49.** (1). As  $\gamma_r = \gamma_a + \gamma_v$   
Where,  $\gamma_r$  = co-efficient of real expansion.  
 $\gamma_a$  = co-efficient of apparent expansion.  
 $\gamma_v$  = co-efficient of expansion of vessel.  
If  $\gamma_r < \gamma_v$ , then the level of liquid will fall in the vessel therefore apparent expansion  $\gamma_a$  will be negative
- 50.** (4). The root mean square speed is inversely proportional to the square root of molecular weight of the gas that is  $C_{r.m.s} \propto \frac{1}{\sqrt{m}}$ .  
Hence heavier the gas smaller is the root mean square velocity.
- 51.** (4). Infrasonic wave velocity is independent of both frequency and wavelength.
- 52.** (3). Magnetic induction at O due to  $I_1$ ,

$$B_1 = \frac{\mu_0}{4\pi} \frac{I_1 \theta}{r} \text{ (directed normally into the plane).}$$

Similarly,

$$B_2 = \frac{\mu_0}{4\pi} \frac{I_2 (2\pi - \theta)}{r} \text{ (directed normally upward to the paper).}$$

Since  $I_2 = \frac{I_1 \theta}{(2\pi - \theta)}$ , so that  $B_2 = B_1$ , but opposite in direction. Therefore net field at O is zero.

- 53.** (2). The average value of alternating e.m.f.,  $E = E_0 \sin \omega t$  over a positive half cycle is,  $E_m = 0.637 E_0$ .
- 54.** (1). Relative velocity of the image w.r.t the object is  $2C$ .
- 55.** (4). The angle subtended at the eye becomes ten times larger. This is the case when tree appears ten times nearer. So for an observer the tree appears to be of length 150 cm.
- 56.** (2). Radius of circular path,  $r = \frac{mV}{qB}$   
for deuteron,  $r_d = \frac{2}{1} \times \frac{V}{B} = \frac{2V}{B}$   
[ since,  $m = 2$  unit,  $q = 1$  units]  
and for helium  $r_{He} = \frac{4 \times V}{2 \times B} = \frac{2V}{B}$   
(since  $m = 4$  unit,  $q = 2$  unit.)  
For same value of  $V$  &  $B$ ,  $r_d = r_{He}$
- 57.** (1). The coloured spectrum is due to diffraction of white light on passing through fine slits made by fine threads in the muslin cloth.
- 58.** (4). In a battery circuit, the point of lowest potential is the negative terminal of the battery. And the current flows from higher potential to lower potential.
- 59.** (3). The speed of sound is 340m/s and speed of light is  $3 \times 10^8$  m/s in air. Thus flash of lightning is seen before the sound of thunder is heard.
- 60.** (1). Time-Period of simple pendulum  $(T) = 2\pi \sqrt{l/g}$ . Thus time-period is inversely proportional to  $\sqrt{g}$  (where  $g$  is acceleration due to gravity). And as the value of 'g' on a satellite is zero, therefore time-period of pendulum is infinity.

## CHEMISTRY

1. Number of moles of proton in one mole of NaCl

- (1). 11 (2). 17  
(3). 28 (4). 56

2. In radioactive transformation  ${}_{92}\text{U}^{238} \rightarrow {}_{82}\text{Pb}^{206}$ , the number of  $\alpha$  and  $\beta$  particles emitted are.

- (1). 10  $\alpha$ , 6  $\beta$   
(2). 4 protons, 8 neutrons  
(3). 6 electrons, 8 protons.  
(4). 6 $\beta$ , 8 $\alpha$

3. Which is more reactive.



4. Which pair among the following have identical bond order?

- (1).  $\text{CN}^-$ ,  $\text{CO}^+$  (2).  $\text{O}_2^-$ ,  $\text{O}_2^+$   
(3).  $\text{CN}^-$ ,  $\text{CN}^+$  (4).  $\text{NO}^+$ ,  $\text{CN}^-$

5. The introduction of neutron into the nuclear composition of an atom would lead to a change in

- (1). The number of neutrino.  
(2). The chemical nature of the atom.  
(3). Its atomic number.  
(4). Its atomic weight.

6. IUPAC name of the compound  $\text{HOOC} - \text{CH}_2 - \text{CH}_2 - \text{CN}$

- (1). 3 cyano propanoic acid.  
(2). 4 nitrile butanoic acid.  
(3). 3 cyano propanaldehyde  
(4). 3 nitrile butanal acid.

7. The compound  $[\text{Cr}(\text{H}_2\text{O})_6]\text{Cl}_3$  and  $[\text{Cr}(\text{H}_2\text{O})_4\text{Cl}_2]\text{Cl}(\text{H}_2\text{O})_2$  represent.

- (1). Linkage isomerism  
(2). Hydrate isomerism.  
(3). Ligand isomerism.  
(4). None of these.

8. Which of the following electronic configurations have the highest exchange energy?

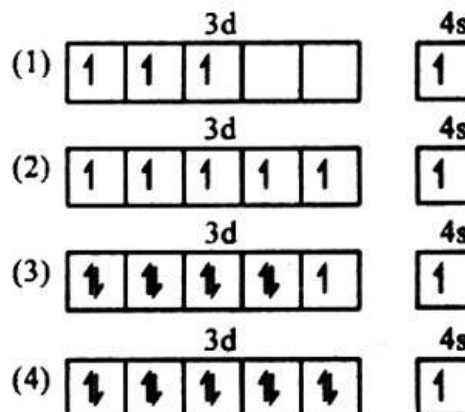

9. Lithopone is a mixture of

- (1).  $\text{Zn SO}_4$ ,  $\text{Ba SO}_4$   
(2).  $\text{Zn S}$ ,  $\text{Ba SO}_4$   
(3).  $\text{Zn CO}_3$ ,  $\text{Ba CO}_3$   
(4).  $\text{Zn S}$ ,  $\text{Na SO}_4$

10. Sputtering of silver is

- (1). Reduction of  $\text{AgNO}_3$  solution.  
(2). Making of silver amalgam during filling of teeth.  
(3). A extraction of silver from its ore  $\text{Ag}_2\text{S}$  by hydrometallurgy.  
(4). Cooling of molten silver with the evolution of oxygen causing violent spurting.

11. Glyptal polymer is obtained from glycerol on reacting with

- (1). Malonic acid. (2). Phthalic acid.  
(3). Maleic acid. (4). Acetic acid.

12. Microcosmic salt is

- (1).  $\text{Na}_2\text{HPO}_4 \cdot 2\text{H}_2\text{O}$   
(2).  $\text{Na}(\text{NH}_4)\text{HPO}_4 \cdot 4\text{H}_2\text{O}$   
(3).  $(\text{NH}_4)_2\text{HPO}_4 \cdot 2\text{H}_2\text{O}$   
(4). None of these

13. Ortho and para hydrogen differs in

- (1). the number of neutron.  
(2). The molecular weight.  
(3). The nature of spin of electron.  
(4). The nature of spin of proton.

14. Which of the following species contain six electrons around the central carbon atom ?

- (1). carbanion. (2). Carbocation.  
(3). Carbene. (4). Free radical.

15. Acetylene reacts with acetic acid in presence of  $\text{Hg}^{2+}$  ions at room temperature to give

- (1). Ethyl acetate (2). Acetaldehyde.  
(3). Vinyl acetate. (4). Methyl acetate.

16. For the reaction



The heat of formation ( $\Delta H$ ) of HI is

- (1). 12.4 Kcal (2). -12.4 Kcal  
(3). -6.20 Kcal (4). 6.20 Kcal.

17. In which of the following reaction  $K_p$  and  $K_e$  are equal

- (1).  $\text{N}_2(\text{g}) + 3\text{H}_2(\text{g}) \rightleftharpoons 2\text{NH}_3(\text{g})$   
(2).  $2\text{SO}_2(\text{g}) + \text{O}_2(\text{g}) \rightleftharpoons 2\text{SO}_3(\text{g})$   
(3).  $\text{N}_2(\text{g}) + \text{O}_2(\text{g}) \rightleftharpoons 2\text{NO}(\text{g})$   
(4).  $2\text{NO}(\text{g}) + \text{O}_2(\text{g}) \rightleftharpoons 2\text{NO}_2(\text{g})$

18. The rate of diffusion of methane at given temperature is twice that of a gas X. The molecular weight of X is

- (1). 64.0 (2). 32.0  
(3). 4.0 (4). 8.0

19. The effect of a catalyst in a chemical reaction is to change the

- (1). Activation energy  
(2). Equilibrium constant.  
(3). Heat of reaction (4). Final product.

20. Which of the following aqueous solutions have higher freezing point ?

- (1). 0.1 m  $\text{Al}(\text{SO}_4)_3$  (2). 0.1 m  $\text{BaCl}_2$   
(3). 0.1 m  $\text{AlCl}_3$  (4). 0.1 m  $\text{NH}_4\text{Cl}$

21. the oxidation number of phosphorus in  $\text{Ba}(\text{H}_2\text{PO}_2)_2$  is

- (1). +3 (2). +2 (3). +1 (4). -1

22. The solution of nickel sulphate in which nickel rod is dipped is diluted to 10 times. The potential of nickel

- (1). Decrease by 60mV  
(2). Increase by 30 V.  
(3). Decrease by 30 mV.  
(4). Decrease by 60 V.

23. Which of the following catalyst is used for preparing toluene by reacting benzene with methyl chloride ?

- (1). Ni (2). Anhydrous  $\text{AlCl}_3$   
(3). Pd (4). Pt.

24.  ${}_{91}\text{Pa}^{234} \longrightarrow {}_{92}\text{U}^{234}$  occurs with the emission of

- (1).  $\alpha$ -Particle (2).  $\beta$ -particle  
(3).  $\gamma$ -rays (4). Positron.

25. The mass of an atom of  ${}^4_2\text{He}$  is 4.0026 amu. The mass of a neutron and a proton are 1.0087 amu and 1.0078 amu respectively. The nuclear binding energy per nucleon is nearly.

- (1). 7 MeV (2). 5 MeV  
(3). 10 MeV (4). 14 MeV

26. Optically active isomers but not mirror images are called

- (1). Enantiomers (2). Mesomers  
(3). Tautomers. (4). Diastereoisomers.

27. Among the following which one is paramagnetic nature species ?:

- (1). Free radical (2). Carbonium ion.  
(3). Both (4). None of these.

28. Which will show geometrical isomerism?

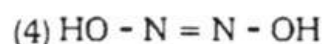
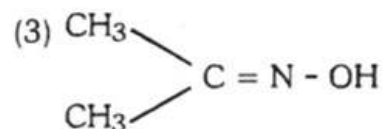
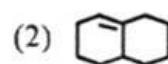

29. State of hybridisation of carbon atom of carbene in the triplet state is

- (1).  $\text{sp}^2$  (2). sp

- (3).  $sp^3$  (4). None of these

30. In the reaction

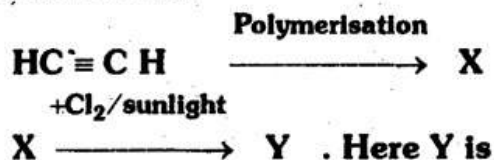

- (1). chloroprene  
(2). trichloroacetaldehyde.  
(3). Polyvinyl chloride  
(4). Benzene hexachloride.

31. Lewisite is very poisonous, are obtained by the action of arsenic trichloride with

- (1). Ethylene (2). Phosgene.  
(3). Acetylene (4). Phosphene.

32. The total number of conformation of ethane are

- (1). Infinite (2). 2  
(3). 3 (4). 4.

33.  $\text{C}_6\text{H}_6 \xrightarrow[\text{v}_2\text{O}_5]{\text{Oxidation}} \text{X}$  . Here x is

- (1). Maleic anhydride (2). Acetic acid.  
(3). Propanoic acid. (4). Succinic acid.

34. Which reaction sequence would be best to prepare 3-chloro-aniline from benzene ?

- (1). Chlorination, nitration, reduction.  
(2). Nitration, reduction, chlorination.  
(3). Nitration, chlorination, reduction.

- (4). Nitration, reduction, Acylation, chlorination, hydrolysis.

35. Tetrabromomethane on treatment with Zn gives

- (1). Ethyl bromide (2). Ethane.  
(3). Ethene (4). Ethyne

36. Steam distillation is used sfor the extraction of

- (1). Fatty acids. (2). Higher alkanes.  
(3). Mineral oils. (4). Essential oils.

37. Which compound on  $\text{KMnO}_4$  oxidation yields phthalic acid ?

- (1). O-Xylene  
(2). Ethyl benzene. (3). O-Cresol  
(4). O-phenylene dichloride.

38. In the Dow's process

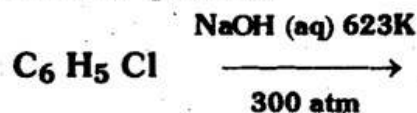

$\text{X} \xrightarrow{\text{HCl}} \text{Y}$  . Here Y is

- (1).  $\text{C}_6\text{H}_5\text{OH}$  (2).  $\text{C}_6\text{H}_5 - \text{CH}_3$   
(3).  $\text{C}_6\text{H}_5 - \text{COOH}$  (4).  $\text{C}_6\text{H}_6$

39. Black ash is

- (1).  $\text{CaS} + \text{NaHCO}_3$  (2).  $\text{CaSO}_4 + \text{Na}_2\text{CO}_3$   
(3).  $\text{Ba SO}_4 + \text{C}$  (4).  $\text{Ca SO}_3 + \text{Na HCO}_3$

40. When an article is bleached by  $\text{SO}_2$  , the colour can be restored by

- (1). Drying  
(2). Heating (3). Exposure to air  
(4). Cannot be restored by these method.

Please visit: [www.easybiologyclass.com](http://www.easybiologyclass.com) for:

- Lecture Notes
- Biology PPTs
- Biology MCQs
- Online Mock Tests (MCQ)
- Video Tutorials
- Practical Aids
- Model Question Papers of NET, GATE, DBT, ICMR Exams
- CSIR NET Life Sciences Previous Year Question Papers
- GATE Previous Year Question Papers
- DBT BET JRF Previous Year Question Papers
- ICMR JRF Entrance Exam Resources
- Jobs Notifications
- Higher Studies in Biology / Life Sciences
- Seminar / Workshop/ Conference Notifications
- And many more....



Please subscribe our **youtube** channel: **easybiologyclass**  
<https://www.youtube.com/user/easybiologyclass/videos>



You can access more PDFs & PPTs from our **Slideshare** account  
<http://www.slideshare.net/EasyBiologyClassEBC/>



Our sister concern: [www.angiospermtaxonomy.com](http://www.angiospermtaxonomy.com)

§ **Directions for Question 41 to 60.** In Assertion reason type question two statements are given, Assertion A and reason R. For answer refer the instruction given below. Write your answer

- (1). If A & R is true and R is correct explanation of A.
- (2). If A & R is true and R is not explanation of A.
- (3). If A is correct R is wrong.
- (4). If R is correct A is wrong

41. A: Glass belongs to the category of covalent net work solid.

- (1) (2) (3)

R: Glass is pseudo solid.

(4)

42. A: Metals are generally good conductor of electricity

- (1) (2) (3)

R: Electrical conductivity of metals are due to schottky type defects.

(4)

43. A: Two electron in an orbital must have opposite spin

- (1) (2) (3)

R: No two electron in an atom can have same set of all four quantum numbers.

(4)

44. A: Alkalimetals are very easily reduced.

- (1) (2) (3)

R: Alkali metals have very low value of ionization energies.

(4)

45. A: Chlorine has higher E.A. than that of fluorine.

- (1) (2) (3)

R: Fluorine is stronger oxidising agent than chlorine.

(4)

46. A: Ionic compounds are generally strong electrolytes .

- (1) (2) (3)

R: Ion has a uniform field of influence around it

(4)

47. A: Carbon tetrachloride is a non-polar molecule.

- (1) (2) (3)

R: The molecule carbon tetrachloride does not contain any polar bond.

(4)

48. A: The order of reaction is always whole number.

- (1) (2) (3)

R: The molecularity of reaction is a whole number other than zero, but generally less than 3.

(4)

49. A: Catalyst increases the rate of the reaction.

- (1) (2) (3)

R: A catalysed reaction proceeds through a new path having lower activation energy.

(4)

50. A: Half life period is always independent of initial concentration.

- (1) (2) (3)

R: Half life period is inversely proportional to rate constant.

(4)

51. A: Lead storage battery does not require salt bridge.

- (1) (2) (3)

R: The solid nature of each oxidising agent and reducing agent prevent direct contact.

(4)

52. A: Anthracene and phenanthrene are isomers.

R: Both have 14  $\pi$  electrons each.



- (1) (2) (3) (4)  
53. A: Kerosene oil floats over water. R: Hydrocarbons are immiscible with water.
- (1) (2) (3) (4)  
54. A: Phenol is stronger acid than alcohols. R: Phenol is stabilized by resonance where as alcohols are not.
- (1) (2) (3) (4)  
55. A: Acetic acid is less soluble in water than benzoic acid. R: Acetic acid dissociates in aqueous solution while it dimerises in  $\text{CCl}_4$ .
- (1) (2) (3) (4)  
56. A: B.P of esters are higher than corresponding isomeric carboxylic acid. R: Acid molecule dimerise in non-aqueous solution.
- (1) (2) (3) (4)  
57. A: Sulphuric acid is more viscous than water. R: In  $\text{H}_2\text{SO}_4$  the S atom exhibit its highest oxidation state.
- (1) (2) (3) (4)  
58. A: Sodium metal is harder than potassium. R: Metallic bond in sodium is stronger than that in potassium.
- (1) (2) (3) (4)  
59. A:  $\text{HBr}$  is stronger acid than  $\text{HI}$ . R: Br is more electronegative than iodine.
- (1) (2) (3) (4)  
60. A: Green edged flame test is meant for testing borate radical. R: Green edged flame is due to burning of ethyl borate.
- (1) (2) (3) (4)

## ANSWERS WITH EXPLANATIONS

1. (3).  
Number of protons in Na = 11.  
Number of protons in Cl = 17  
Number of protons NaCl = 11 + 17 = 28
2. (4).  ${}_{92}\text{U}^{238} \longrightarrow {}_{82}\text{Pb}^{206} + 6 {}_{-1}^0\text{e} + 8 {}_{2}^4\text{He}^{++}$
3. (1).  

  
due to electron withdrawing nature of  $\text{C}_6\text{H}_5$  - group  $\text{C}_6\text{H}_5\text{OH}$  is more reactive.
4. (4).  $\text{NO}^+$  and  $\text{CN}^-$  has same number of outer most electrons, so it will occupy same bonding & antibonding orbital.
5. (4). Increase in the number of neutron will increase the mass number by one unit.
6. (1).  $\text{HOOC} - \text{CH}_2 - \text{CH}_2 - \text{CN}$   
3-Cyanopropanoic acid
7. (2). Hydrate isomerism arises in the complexes due to different number of water molecules present in the co-ordination spheres.  
For example  $[\text{Cr}(\text{H}_2\text{O})_6] \text{Cl}_3$   
and  $[\text{Cr}(\text{H}_2\text{O})_4 \text{Cl}_2] \text{Cl}(\text{H}_2\text{O})_2$
8. (2).  

3d					4s
1	1	1	1	1	1

  
has the highest exchange energy.
9. (2). Lithopone is used as white pigment. Its chemical composition is  $\text{BaSO}_4 + \text{ZnS}$ .

10. (4). The process in which atoms are ejected from a solid surface.

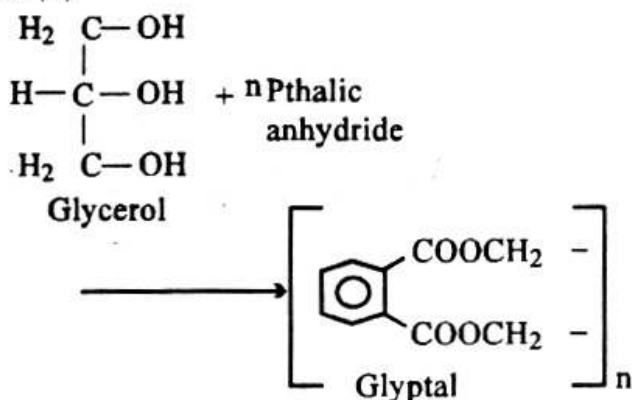
11. (2).



12. (2) Sodium ammonium hydrogen phosphate  $\text{Na NH}_4 \text{HPO}_4 \cdot 4\text{H}_2\text{O}$  is also known as microcosmic salt. Molten salt solidifies to glasses which gives characteristic colours with certain metals.

13. (4). The hydrogen molecule,  $\text{H}_2$  exist in two forms because of difference in the relative spin of the nuclei of two atoms. When both spin in the same direction is called para hydrogen when spin in opposite direction is called ortho hydrogen.

14. (3). Carbocation and carbene has six electrons around central carbon atom

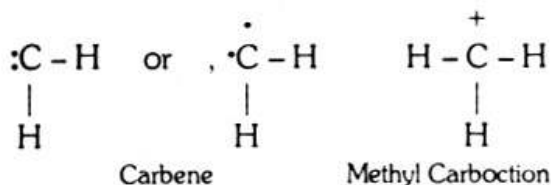

15. (3)

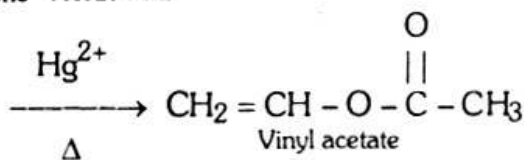

16. (4). By definition  $\Delta H_f$  for one mole

$$= \frac{12.4}{2} = 6.02 \text{ k cal}$$

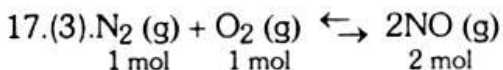

$\Delta n(\text{g}) = 0$  ( reactants and product are in the same amount )

$\therefore K_p$  and  $K_c$  are equal when  $\Delta n(\text{g})$  is equal to zero.

$$\begin{aligned}
 18. (1). \frac{\gamma_{\text{CH}_4}}{\gamma_x} &= \sqrt{M_x / M_{\text{CH}_4}} \\
 2 &= \sqrt{M_x / 16} \\
 M_x &= 64
 \end{aligned}$$

19. (1). Catalyst are specific in nature and can alter only the rate of reaction. They cannot change  $\Delta E$ ,  $\Delta H$  or  $\Delta G$  of a reaction. Catalyst only change the activation energy.

20. (4) Lesser the number of particle in the solution lesser the depression in freezing point. It means higher be the freezing point.

21. (3). Let oxidation No. of P = x ( oxidation NO. of Ba = +2, H = +1, O = -2)

$$\begin{aligned}
 \therefore 2 \times 1 + 4 \times 1 + 2 \times x + 4 \times (-2) &= 0 \\
 x &= +1.
 \end{aligned}$$

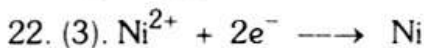

$$\begin{aligned}
 E &= E^\circ + \frac{0.059}{2} \log \frac{[\text{Ni}^{2+}]}{[\text{Ni}]} \\
 &= E^\circ + \frac{0.059}{2} \log 1 \times 10^{-1} \\
 &= (E^\circ - 0.03) \text{ volts}
 \end{aligned}$$

23. (2).

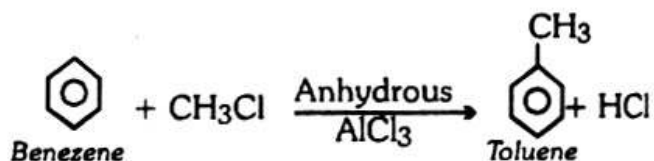

After emission of one  $\beta$ -particle mass number doesn't changes but atomic number increases by one unit, because one neutron converted in to proton.

25. Mass defect

$$\begin{aligned}
 &= [2 (1.0087 + 1.0078) - 4.0026] \text{ amu.} \\
 &= 0.0304 \text{ amu.}
 \end{aligned}$$

$$\begin{aligned}
 \text{Binding energy} &= 0.0304 \times 931.48 \text{ MeV.} \\
 &= 28.32 \text{ MeV.}
 \end{aligned}$$

$$\begin{aligned}
 \text{Binding energy per nucleon} &= \frac{28.32}{4} \text{ MeV.} \\
 &\approx 7 \text{ MeV}
 \end{aligned}$$

26. (4). Stereoisomers that are not mirror images of each other are called diastereo isomers.

27. (1). Free radicals are paramagnetic in nature due to the presence of unpaired electrons in them.

N=N provides restricted rotation. -OH group and lone pair of electrons distribution causes 'cis' and 'trans' forms.

28. (4).

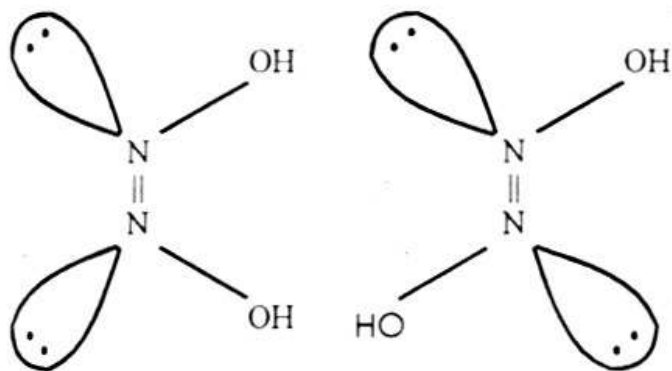

29. (2). The state of hybridization of carbon in triplet carbene is sp.

30. (4).

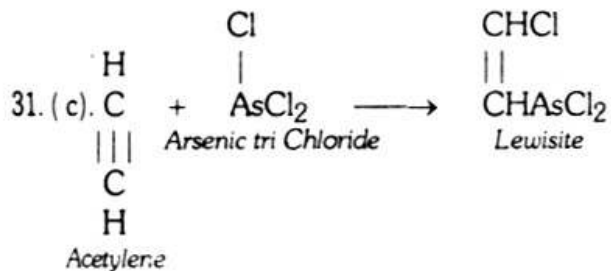
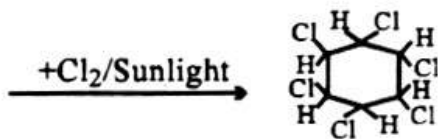
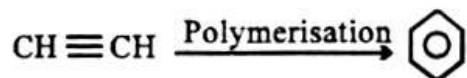

32. (1). There are three main conformation of ethane. i.e., eclipsed, staggered and skew. But in the case of skew conformation infinite conformations are possible.

33. (1)

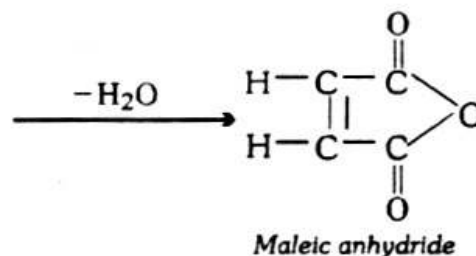
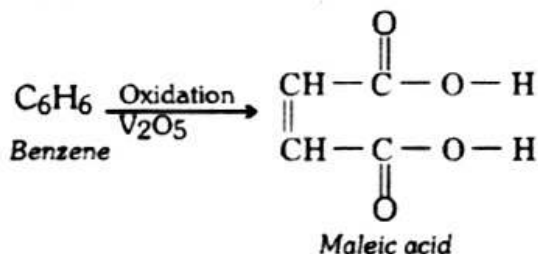

34. (3).

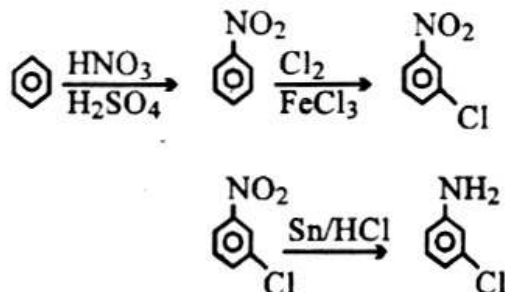

35. (4).

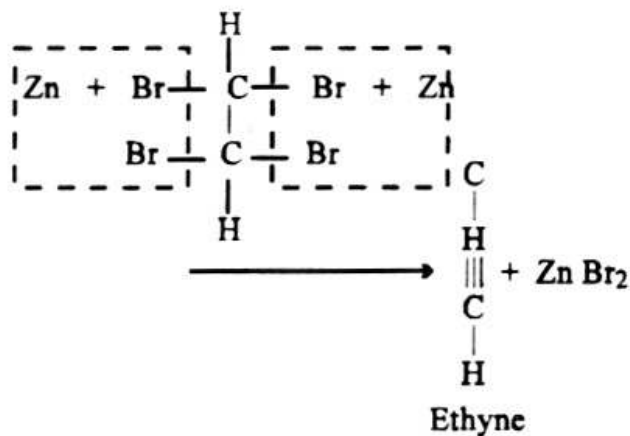

36. (4). Essential oils are steam volatile, therefore these are extracted from flowers, fruits, seeds, etc., of various plants by steam distillation.

37. (1).

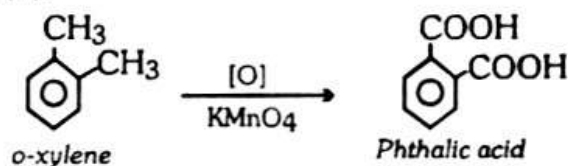

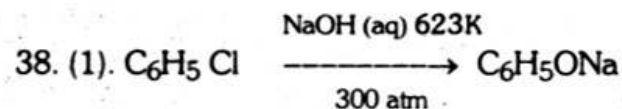

39. (3). Black ash is Barium sulphide an important intermediated in Ba chemistry ( $\text{BaSO}_4 + \text{C}$ ).
40.  $\text{SO}_2$  Bleaches the colour by reduction and on exposure to air, colour is restored due to oxidation.
41. (3). reason is wrong because glass is super cooled liquid.
42. (3). reason is wrong because electrical conductivity of metal is due to free electron.
43. (1). Pauli's exclusion principle states that "No two electron of an atom can have all the four sets of quantum numbers are identical". So R explains A.
44. (4). A. is wrong because alkali metals has tendency to reduce others and itself get oxidise. easily.
45. (2). E.A is energy released during introduction of one electron in an isolated atom. Because of smaller size of fluorine, inter electronic repulsion is higher as compared to chlorine. To overcome this repulsion some amount of energy is needed. So final energy released is less than that of chlorine hence EA is less than chlorine.
46. (2). Ionic compounds are generally strong electrolytes because it can give or breaks in to constituent ions very easily.
47. (3).  $\text{CCl}_4$  contain polar bond but due to its symmetry this compound does not show polarity. Hence dipole moment is zero.
48. (4). The order of reaction is the experimental value it may be the whole number or it may be the fractional or decimal figure like, 1,2,3 or 1.5, 2, 3 etc.
49. (1). By decreasing activation energy catalyst increases the rate of reaction.

50. (4). For first order reaction half life period is independent of initial concentration but for others it depends up on initial concentration.  
e.g.,  $T_{1/2} = \frac{1}{K[A_0]}$  for 2nd order reaction half life is inversely proportional to initial concentration.
51. (1). The solid nature of cathode & anode /oxidising agent & reducing agent prevent, from direct contact. That is why lead storage battery does not required salt bridge.
52. (2). Anthracene and phenanthrene has same number of carbon & hydrogen i.e.,  $\text{C}_{14}\text{H}_{16}$ . The same number of  $\pi$  electrons are not the criteria of isomerism.
53. (2). Kerosene is lighter than water that is why it floats over water, since it is hydrocarbon, non polar compound it does not dissolves in water. But 2nd criteria is only responsible or dissolution, not for floating.
54. (2).  $\text{C}_6\text{H}_5^-$  is electron withdrawing group which attracts electron of H atom and  $\text{H}^+$  can liberated very easily but any alcohol like R-OH. R-is electron pumping in nature which does not attract the electron of H atom and cannot give  $\text{H}^+$  ion easily.
55. (4). Acetic acid is more soluble in water than benzoic acid.
56. (4). B.P. of esters are lower than corresponding isomeric carboxylic acid.
57. (2). Sulphuric acid is more denser than water.
58. (1). Metallic bond in sodium is stronger than that of potassium that is why Na is harder metal than K.
59. HI is stronger acid than HBr.
60. (2). Green edged flame test is meant for the test of interfering radical i.e., borates in which ethyl alcohol is mixed with salt paste and set in fire.

**PART III BIOLOGY**

**1. Which of the following is absent in prokaryotes?**

- (1) Mitochondria (2) DNA  
(3) RNA (4) Plasma membrane

**2. In pollen mother cells cytokinesis during meiosis is**

- (1) Simultaneous type  
(2) Successive type  
(3) In some cases successive type while in others simultaneous type  
(4) No cytokinesis takes place

**3. Mendel's law were first published in the year**

- (1) 1865 (2) 1928 (3) 1890 (4) 1875

**4. Theory of directed panspermia about origin of life was given by**

- (1) Haeckel (2) Watson  
(3) Crick (4) Khorana

**5. Which of the following is effective against mycoplasmal diseases**

- (1) Chloramphenicol (2) Penicillin  
(3) Vancomycine (4) All the above

**6. Which of the following is not a member of thallophyta**

- (1) Mucor (2) Moss  
(3) Spirogyra (4) Both (1) and (2)

**7. Mesophyll tissue of *Pinus* needle is composed of**

- (1) Transfusion tissue (2) Spongy parenchyma  
(3) Chlorenchyma (4) Armed parenchyma

**8. Development of embryo from the cells the nucellus is called**

- (1) Apospory (2) Apocarpary  
(3) Parthenocarpary (4) Adventive embryony

**9. Occurrence of more than four spores from a spore mother cell is called**

- (1) Polysiphony (2) Polyembryony  
(3) Polyspory (4) Polyspermy

**10. Vascular cambium is a meristematic layer that cuts off**

- (1) Secondary xylem and secondary phloem  
(2) Primary xylem and secondary xylem

- (3) Xylem vessels and xylem tracheids  
(4) Primary xylem and primary phloem

**11. Endodermis of dicot stem is also called**

- (1) Pith (2) Mesophyll  
(3) Starch sheath (4) Bundle sheath

**12. The cabbage become brown due to deficiency of**

- (1) Nitrogen (2) Boron  
(3) Calcium (4) Sodium

**13. The part of the plant where metabolism takes place is called**

- (1) Underground (2) Sub-aerial  
(3) Aerial (4) All the above

**14. The plant from which there is rapid transpiration, it will show**

- (1) Active osmotic absorption  
(2) Active non-osmotic absorption  
(3) Passive absorption  
(4) Active absorption

**15. Which of the following is called necessary evil**

- (1) Photosynthesis (2) Transpiration  
(3) Absorption (4) Osmosis

**16. Which of the following is black-yellow pigment of carrot roots**

- (1) Fucoxanthin (2) Violoxanthin  
(3) Beta-carotene (4) Alpha-carotene

**17. For each molecule of glucose formed in plants, the number of molecule of ATP and NADPH<sub>2</sub> required are respectively**

- (1) 33 and 22 (2) 15 and 10  
(3) 18 and 12 (4) 12 and 18

**18. Krebs has been awarded Nobel Prize in 1953 for explaining**

- (1) Oxidation of cytoplasm  
(2) Respiration chain  
(3) ATP metabolism  
(4) Energy forming process in the cell

**19. Which of the following observation most strongly support the view that mi-**

Print less... Save paper... Save trees... Save our Earth!  
**tochondria contain electron transfer enzymes aggregated into compact associations**

- (1) Mitochondria in animal embryos have a tendency to concentrate in cells which are to become part of locomotory structures
- (2) Disruption of mitochondria yields membrane fragments which are able to synthesize ATP
- (3) Mitochondria have highly folded inner wall
- (4) A contractile protein capable of utilizing ATP has been obtained from mitochondria

**20. Example of amide enzyme is**

- (1) Lipase
- (2) Zymase
- (3) Lactase
- (4) Arginase

**21. Indicate the correct match in the following:**

- (1) VI cranial nerve---External rectos muscle of eye
- (2) VI cranial nerve--- Lower jaw muscle
- (3) V cranial nerve--- Heart
- (4) I cranial nerve ---Vagus

**22. A structure that helps a person to maintain his balance is:**

- (1) Eustachian tube
- (2) Hammer
- (3) Cochlea
- (4) Semicircular canal

**23. A gorilla-like appearance with huge hands and legs is due to abnormal secretion of :**

- (1) GH
- (2) LT.
- (3) LH
- (4) FISH

**24. Major part of semen is secreted by:**

- (1) Bartholin's gland
- (2) Compeer's gland
- (3) Seminal vesicle
- (4) Prostate gland

**25. Sensory receptors such as retina develop from:**

- (1) Mesoderm
- (2) Endoderm
- (3) Ectoderm
- (4) None

**26. The reconstitution of the whole body from small fragments is called:**

- (1) Atutotomy
- (2) Repair
- (3) Morphallaxis
- (4) Epimorphosis

**27. When a plant of  $F_1$  generation is crossed with homozygous dominant parents, it is known as:**

- (1) test cross
- (2) back cross
- (3) special cross
- (4) simple cross

**28. Each chromosome carries a distinct region which plays a fundamental role in chromosome movement during mitosis. This region is:**

- (1) telemeter
- (2) centriole
- (3) chromatic
- (4) centromere or kinetochore

**29. Restriction endonucleases are:**

- (1) used for in virtue synthesis
- (2) synthesized by bacteria as part of their defense mechanism
- (3) used in genetic engineering for fighting two DNA molecules
- (4) present in mammalian cells for degeneration of DNA when the cell dies

**30. Mental competence in relation to chronological age in man is called:**

- (1) Intelligence quotient
- (2) Intelligence
- (3) Diligence
- (4) Idiocy

**31. According to chemosynthetic generation theory, the sequence of origin of life may be considered as:**

- (1) Chlorophyll, nucleic acids, amino acids
- (2) Nucleic acids, amino acids, chlorophyll
- (3) Chlorophyll, starch, glycogen
- (4) Amino acids, nucleoproteins, chlorophyll

**32. Cyanophages were discovered by:**

- (1) Tort and de'Herelle
- (2) Lederberg and Taut
- (3) Jack and Monad
- (4) Safferman and Morass

**33. Doctrine of evolution is concerned with:**

- (1) special creation theory
- (2) biogenesis
- (3) biogenesis
- (4) gradual changes

**34. The stone tools made by *Homo herbals* are called:**

- (1) Aurignacian tools  
 (2) Acheulean tools (3) Oldowan tools  
 (4) None of these

**35. The botanical insecticide azadirachtin is obtained from:**

- (1) Enema (2) Algae  
 (3) Bacillus (4) Tobacco

**36. Which of the following is the cancerous state of blood?**

- (1) Cholera (2) Proteinemia  
 (3) Leukemia (4) Uremia

**37. The first true vaccine, consisting of weakened microorganisms, against chicken cholera was developed in 1880 by :**

- (1) Christian Barnard (2) Josh Listed  
 (3) Robbers Loch (4) Louis Pastier

**38. Narcotics are obtained from:**

- (1) *Foeniculum vulgare*  
 (2) *Palaver somniferous*  
 (3) *Digitalis pursuer*  
 (4) *Solarium tuberosus*

**39. Which of the following can study the metabolic and chemical activity of tissues?**

- (1) NM (2) MI  
 (3) PET imaging (4) None of these

**40. Which of the following microorganisms is used for production of citric acid in industries?**

- (1) *Aspergillus Nigeria*  
 (2) *Lactobacillus buglers*  
 (3) *Penicillin citrirum*  
 (4) *Rhizomes Nigerians*

**Directions for Question . 41 to 60. : These questions consist of two statements each, printed as Assertion and Reason. While answering these questions you are required to choose any one of the following four responses.**

- A. If both the Assertion and Reason are true and the Reason is a correct explanation of the Assertion.  
 B. If both the Assertion and Reason are true but the Reason is not a correct explanation of the Assertion.  
 C. If the Assertion is true but the Reason is false.  
 D. If the Assertion is false but the Reason is true.

1. Assertion : The preparation of recombinant DNA requires restriction enzymes.

Reason : Because these are not used to cleave plasmid DNA.

2. Assertion : B-cells are responsible for antibody mediated immunity which directly recognize an antigen and give rise to antibody secreting plasma cells and memory B-cells.

Reason : Immunity can be induced by using vaccines for long-lived active period.

3. Assertion : Flagella found in green algae are of tirse type.

Reason : The flagella found in green algae have a smooth surface and are called whiplash or acronematic.

4. Assertion : Choroid plexus is one of two thin-walled greatly folded highly vascular regions in the inner wall of the brain through which exchange of materials between blood and cerebrospinal fluid takes place.

Reason : The choroid plexuses (which form the blood-brain barrier) bar the entry of blood cells and large molecules into the cerebrospinal fluid.

Assertion: Specialization of cells is advantageous for the organism.

Reason : It increases the operational efficiency of an organism.

46. **Assertions:** In bacteria, photosynthesis occurs by utilizing wavelengths longer than 700 nm.
- Reason : Here the reaction centre is B-890.
47. **Assertion :** Increase in the quantity of metabolically active protoplasm, accompanied by an increase in cell number and cell size is called growth movement.
- Reason : Growth, in plants, is restricted to specific regions having meristematic tissue.
48. **Assertion :** The tropic movements occurring in response to water stimulus are called haptotropic movements.
- Reason : Haptotropic movements occur in response to a touch or contact.
49. **Assertion :** Macro-evolution produces groups of parallel special adaptations among convergent but related animal species.
- Reason : Adaptive radiation or macro-evolution tends to produce evolutionary lines that converge in special adaptation with other distantly related groups differing in their matrix of general adaptation.
50. **Assertions:** WBCs accumulate at the site of wounds by diapedesis.
- Reason : It is the squeezing of leucocytes from the endothelium.
51. **Assertions:** Lateral line system is found in fishes and aquatic larval amphibians.
- Reason : Lateral line system has receptors which are the clusters of sensory cells derived from ectoderm.
52. **Assertion :** Symbiosis is also furnished by mycorrhiza.
- Reason : In this case symbiosis is established between alga and fungus.
53. **Assertion :** Some bacterial and eukaryotic DNA polymerases can replace a nucleotide and insert it correctly. DNA ligase then seals the phosphodiester bond. To avoid removing the nucleotide from the wrong strand, cells methylate DNA which has been formed some while; repair enzymes thus distinguish old from new DNA.
- Reason : Mutant lacking repair mechanism are likely to be more susceptible to irradiating sources and express mutations so induced.
54. **Assertion :** Deamination occurs by transaminase enzymes in the kidney.
- Reason : Removal of an amino-group ( $-NH_2$ ) from an amino acid is used in production of urea.
55. **Assertion :** When the chromosomes are highly coiled and condensed at the time of cell division, it is not possible to photograph and count them.
- Reason : Each species has a characteristic chromosome number.
56. **Assertion:** The imbalance in the concentration of  $Na^+$ ,  $K^+$  and proteins generates the resting potential.
- Reason : To maintain the unequal distribution of  $Na^+$  and  $K^+$ , the neurons use electrical energy.
57. **Assertion :** Xylem transports water and dissolved mineral salts from the roots to the rest of the plant.
- Reason : Phloem translocates dissolved organic and inorganic solutes.



58. Assertion: Clones are a group of organism of identical genotype, produced by same kind of sexual reproduction and same sexual processes.

Reason : These are prepared by a group of cells descended from many cells or by inbreeding of a completely heterozygous line.

59. Assertion : S-A node is called the 'contraction centre' or 'pacemaker'.

Reason : The node fibres of S-A node are embedded in the wall of right atrium.

60. Assertion: Histamine is involved in allergic and inflammatory reactions.

Reason : Histamine is a vasodilator.

## ANSWERS

- 1.(1) 2.(3) 3.(1) 4.(3) 5.(1) 6.(2) 7.(2) 8.(4) 9.(3) 10.(1) 11.(3) 12.(2)  
 13.(4) 14.(3) 15.(2) 16.(3) 17.(3) 18.(4) 19.(2) 20.(4) 21. (1) 22. (4) 23.  
 (1) 24. (3) 25. (3) 26. (3) 27. (2) 28. (4) 29. (2) 30. (1) 31. (4) 32. (4)  
 33. (4) 34. (3) 35. (1) 36. (3) 37. (4) 38. (2) 39. (3) 40. (1). 41. (3). 42.  
 (2). 43. (4). 44, (2). 45. (1). 46. (2). 47. (4). 48. (4). 49. (4). 50. (2). 51.  
 (2). 52. (2). 53. (2). 54. (4). 55. (4). 56. (3). 57. (2). 58. (3). 59. (1). 60.  
 (1).

## Hints

- 1 (1). Prokaryotic cells lack true nucleus & membrane bound organelles such as mitochondria, chloroplast, E.R., golgi bodies etc.
- 2 (3). In cavity of megasporangium the microspore mother cell divides meiotically to produce pollen tetrad. Cytokinesis may occur after each meiotic division (Successive) thus isobilateral tetrad of microspore is formed (monocot) or it occurs after both meiosis I & II division (simultaneous) thus tetrahedral tetrads of microspore is produced e.g., dicot. Successive type of cytokinesis is advanced type.
- 3 (1). Gregor John Mendel worked on garden pea - *Pisum sativum* by taking 7 traits for 8 years from 1856 to 1864 & presented his postulates in 1865 which were published in 1866 in an obscure journal 'Proceedings of Braunschweig Natural History Society'.
4. (3). Theory of Directed Panspermia was given by Crick.
5. (1). Chlorophenicol is effective drug against mycoplasmal infection because it affects protein machinery i.e., Ribosomes of mycoplasma.
6. (2). Moss belongs to bryophyte which is not thallophyte. Thallophytes consist of Algae & Fungi.
- 7 (2). Spongy parenchyma is present in mesophyll cells of Pinus needles.
8. (4). The embryo developing from nucellus or integument all known as adventive embryo & process is called adventive polyembryony.
9. (3). Usually spore mother cell divide meiotically to produce 4 spores but some times more spores are produced due to followed mitosis is called as polyspory.
10. (1). Vascular cambium consist of inter & intrafascicular cambium responsible for secondary growth which cuts secondary xylem

- toward inner side & secondary phloem toward outer side.
11. (3). Endodermis is inner most layer of cortex which is starch fluid in dicots & surrounds stele, hence called bundle sheath.
  12. (2). Boron deficiency leads to brown heart of turnip & browning of cabbage.
  13. (4). Metabolism means all anabolic (forming) & catabolic (breaking) activities e.g., like photosynthesis & respiration. These activities are characteristics of all living cells.
  14. (3). Due to more transpiration there would be more transpiration pull and water potential in root would be more negative than outside, so water would rapidly move into roots without expenditure of energy i.e., by passive absorption.
  15. (2). According to Curtis "Transpiration is necessary evil" because although it wastes energy since 95% of water absorbed is lost but it helps in uptake of mineral & water from soil.
  16. (3). Carrot root contains  $\beta$  - Carotene which is a carotenoid.
  17. (3). During process of photosynthesis for formation of one molecule of glucose, 18 ATP & 12 NADPH<sub>2</sub> are required. The overall reaction could be represented as -
 
$$\begin{array}{l}
 6 \text{ CO}_2 + 12 \text{ H}_2\text{O} + 12 \text{ NADPH}_2 + 18 \text{ ATP} \\
 \xrightarrow[\text{Chlorophyll}]{\text{Sunlight}} 1 \text{ Glucose} + 6 \text{ H}_2\text{O} + 6 \text{ O}_2 \\
 + 12 \text{ NADP} + 17 \text{ ADP} + \text{H}_3\text{PO}_4
 \end{array}$$
  18. (4). Krebs has been awarded nobel prize in 1953 for explaining energy forming process in the cell. He proposed a cycle of reaction to explain how pyruvate break down occur in breast muscle of pigeon & named it citric acid cycle. Now it is also called Krebs cycle.
  19. (2). Mitochondrial membrane have F<sub>0</sub> - F<sub>1</sub> particles complex which are called ATPase particle which are responsible for conversion of ADP into ATP by oxidation of respiratory substrate during which electrons are passed into electron transport chain having enzymes which remain aggregated into compact association & even when mitochondrial fragments are broken, ATP generation takes place.
  20. (4). Arginase is amidase enzymes & acts on amide group.
  21. (1). VI cranial nerve (Abducens) originate from the side of medulla and distributed in the external rectus muscle of eyeball. Its function is rotation of eyeball.
  22. (4). Semicircular canals - three arc-shaped tubes containing fluid (endolymph) and forming part of the membranous labyrinth of the vertebrate ear. The function of the semicircular canals is to detect acceleration and change of position and to give a sense of balance.
  28. (4). Spindle fibers are attached to the kinetochore of centromere and pulls the chromosome to the respective poles.
  29. (2). Restriction endonuclease is an enzyme synthesized by bacteria to cleave any foreign DNA that enters the bacteria. But it does not cleaves of its own DNA because of a specific pattern of methylation in the DNA.
  36. (3). Leukemia is the uncontrolled production and accumulation of different white blood cells.
  41. (C). The preparation of recombinant DNA (r-DNA) requires restriction enzymes, which are used to cleave plasmid DNA and to cleave foreign DNA.
  42. (B). Active immunity can be induced by using a vaccine for a short period.
  43. (D). Flagella found in green algae are of whiplash types.
  44. (B). Both the Assertion and Reason are true but the Reason is not a correct explanation of the Assertion.
  45. (A). Specialization of cells into tissue, organ and organ systems is advantageous for the organism. It increases the operational efficiency through division of labour which avoids duplication of work.
  46. (B). In bacteria, the reaction centre is B-89 and photosynthesis occurs by utilizing wavelengths longer than 700nm. The reductant NADH + H<sup>+</sup>. In bacteria, the donor may be

- hydrogen sulphide or malate or succinate but not water.
47. (D). Increase in the quantity of metabolically active protoplasm, accompanied by an increase in cell number or cell-size or both are known as growth.
  48. (D). The tropic movements occurring in response to water stimulus are called hydrotropic movements.
  49. (D). Macro-evolution produces groups of parallel special adaptations among divergent but related animal species.
  50. (B). During a wound, germs are removed by the process of phagocytosis by WBS. WBCs accumulate at the site of wound by diapedesis. It is the squeezing of leucocytes out from the endothelium of capillaries to fight against foreign agent.
  51. (B). Lateral line system is a sensory system of fishes and aquatic and larval amphibians whose receptors are clusters of sensory cells derived from ectoderm. These clusters of sensory cells are called neuromast organs.
  52. (B). Symbiosis is also furnished by mycorrhiza. In this case a fungus establishes a relationship with the roots of certain higher plants.
  53. (B). The DNA repair mechanism is distinctively repair of phosphodiester bond, insertion of correct sequences, removing extra wrong strands. This mechanism is more susceptible to irradiating sources.
  54. (D). Removal of an amino ( $-NH_2$ ) group frequently from an amino acid, by transaminase enzymes. In mammals it occurs chiefly in the liver, where the amino group is used in production of urea. This process is important in gluconeogenesis, where resulting carbon skeleton yield free glucose.
  55. (D). When the chromosomes are highly coiled and condensed during cell division, it is possible to photograph and count them.
  56. (C). To maintain the unequal distribution of  $Na^+$  and  $K^+$  ion, the neuron uses chemical energy in the form of ATP to actively transport  $Na^+$  ion out of the cell and move  $K^+$  inside the cell.
  57. (B). *Phloem* translocates dissolved organic and inorganic solutes, whereas *Xylem tissue* transports water and mineral salts from the roots to the rest of the plant.
  58. (C). Clone is a group of cells descended from the same single parent cell. In most of the cases, nucleic acid sequences are said to be cloned when they are inserted into vectors such as plasmids and copied within host cells during gene manipulation.
  59. (A). Pacemaker is a specialized cell or group of cells that automatically generate impulses that may spread to other regions of the heart. The normal cardiac pacemaker is the sinoatrial node, a group of cells in the atrium near the entrance of the superior vena cava into the right atrium. Obviously, the impulses of heart beat originate in the fibres.
  60. (A). Histamine is a derivative of the amino acid histidine produced by damaged cells of vertebrates. When released, it has the effect of dilating capillaries and lowering blood pressure. Histamine is involved in allergic and inflammatory reactions.

**GENERAL KNOWLEDGE**

- 1. Who was the last Viceroy of India?**
  - (1) Lord Linlithgow
  - (2) Lord Irwin
  - (3) Lord Mountbatten
  - (4) Lord Wavell
- 2. By which of the following Amendments to the Constitution, the fundamental duties of the citizens have been enumerated?**
  - (1) 79th
  - (2) 77th
  - (3) 44th
  - (4) 42nd
- 3. First World Cup-Football was held in the year \_\_\_\_\_?**
  - (1) 1922
  - (2) 1930
  - (3) 1944
  - (4) 1954
- 4. Time Magazine's Person for the year 2001 was \_\_\_\_\_?**
  - (1) Collin Powell
  - (2) George Bush
  - (3) Rudolft Guilani
  - (4) Mike Monore
- 5. Which of the following Indian movies was nominated in the category of foreign language film for 74th Oscar Awards - 2002?**
  - (1) Monsoon wedding
  - (2) Gadar : Ek Prem Katha
  - (3) Lagaan
  - (4) Dil Chahta Hai
- 6. Which of the following is not a SAARC member?**
  - (1) Pakistan
  - (2) Sri Lanka
  - (3) Thailand
  - (4) Bhutan
- 7. Which state was most affected by earthquake tremors in the year 2001?**
  - (1) Maharashtra
  - (2) Gujarat
  - (3) Assam
  - (4) Bihar
- 8. 'Bhabha Atomic Research Centre' is situated in which of the following cities?**
  - (1) New Delhi
  - (2) Mumbai
  - (3) Chennai
  - (4) Ranchi
- 9. The first Space Shuttle Commanded by Woman was - - - - ?**
  - (1) Shenzhou
  - (2) Vostok
  - (3) Apollo-II
  - (4) Columbia
- 10. In which city 'Human Organ Development Centre for Transplantation' is going to be established?**
  - (1) Mumbai
  - (2) New Delhi
  - (3) Chennai
  - (4) Hyderabad
- 11. Which is the highest rank in Navy?**
  - (1) General
  - (2) Admiral
  - (3) Commander
  - (4) Brigadier
- 12. Term 'Jigger' is used in which of the following sports?**
  - (1) Horse racing
  - (2) Bridge
  - (3) Polo
  - (4) Billiards
- 13. "Jalianwala Bagh tragedy" occured in**
  - (1) 1857
  - (2) 1909
  - (3) 1919
  - (4) 1921
- 14. Golden jubilee of Indian Parliament was celebrated on \_\_\_\_\_?**
  - (1) 15th Aug 2000
  - (2) 15th Aug 1997
  - (3) 24th January 2000
  - (4) 13th May 2002
- 15. The first state to introduce tele-agriculture in India is \_\_\_\_\_?**
  - (1) Punjab
  - (2) Haryana
  - (3) Rajasthan
  - (4) Karnataka
- 16. 'Gayatri Mantra' is part of which of the following Vedas?**
  - (1) Sam Veda
  - (2) Atharth Veda
  - (3) Rig Veda
  - (4) Yajur Veda
- 17. "Gulliver's Travels" was written by**
  - (1) Jonathan Swift
  - (2) A. Dante
  - (3) V. Nobokov
  - (4) Adam Smith
- 18. Asian Games 2002 will be held in**
  - (1) Hiroshima
  - (2) Pusan
  - (3) Rome
  - (4) Doha
- 19. The founder of "Arya Samaj" was**
  - (1) Raja Ram Mohan Rai
  - (2) Swami Vivekanand
  - (3) Swami Dayanand Saraswati
  - (4) Ram Krishan Paramhans
- 20. National Defence Academy is situated in**
  - (1) Dehradun
  - (2) Mysore
  - (3) Pune
  - (4) New Delhi

1. (3) Lord Mountbatten was the last Viceroy of India.
2. (4) 42nd amendment was made in the year 1976.
3. (2) It was held at Uruguay and 13 countries participated in first football world cup.
4. (3) Rudolft Guilani - Mayor of Newyork. He was given this award for the leadership and quick action in the wake of September 11, 2001 on twin towers (World Trade Centre).
5. (3) Lagaan. This Oscar Award - 2002 was given to the film 'No mens land' of 'Bosinia harzegovina'.
6. (3) Thailand. Bangladesh, Bhutan, India, Maldives, Nepal, Pakistan and Sri Lanka are the members of South Asian Association for Regional Cooperation (SAARC).
7. (2) Gujarat. 26th January, 2001.
8. (2) Mumbai
9. (4) Columbia. Woman Col. Eileen Collins blast off into space from Cape Canaveraf, Florida, U.S.A.
10. (4) Hyderabad. In this centre organs like kidney, liver, pancreas etc. would be developed and transplanted.
11. (2) Admiral.                      12. (4) Billiards
13. (3) 13.4.1919. One this day, hundreds of Indians were shot by the order of General Dayyor. Bhagat Singh took the revenge by killing General Dayyor.
14. (4) 13 May 1952 was the day on which first meeting of Indian Paliaments was held. So golden jublee was celebrated on 13 May 2002.
15. (2) Tele-agriculture is the scheme introduced by Govt. of Haryana in which the state farmers can refer their problems to the experts in various fields in the department of agriculture over phone.
16. (3) Rig Veda                      17. (1) Jonathan Swift
18. (2) Pusan (South Korea)
19. (3) Swami Dayanand Saraswati (1875)
20. (3) Khadakvasala, Pune.

Please visit: [www.easybiologyclass.com](http://www.easybiologyclass.com) for:

- Lecture Notes
- Biology PPTs
- Biology MCQs
- Online Mock Tests (MCQ)
- Video Tutorials
- Practical Aids
- Model Question Papers of NET, GATE, DBT, ICMR Exams
- CSIR NET Life Sciences Previous Year Question Papers
- GATE Previous Year Question Papers
- DBT BET JRF Previous Year Question Papers
- ICMR JRF Entrance Exam Resources
- Jobs Notifications
- Higher Studies in Biology / Life Sciences
- Seminar / Workshop/ Conference Notifications
- And many more....



Please subscribe our **youtube** channel: **easybiologyclass**  
<https://www.youtube.com/user/easybiologyclass/videos>



You can access more PDFs & PPTs from our **Slideshare** account  
<http://www.slideshare.net/EasyBiologyClassEBC/>



Our sister concern: [www.angiospermtaxonomy.com](http://www.angiospermtaxonomy.com)